

JVC

SERVICE MANUAL

STEREO RECEIVER

MODEL

R-X110/R-X110B
R-X110L/R-X110LB

R-X 150



R-X110



R-X110L

R-X 150

Model	Version	
	Feature	Color
R-X110	—	Silver
R-X110L	with LW	Silver
R-X110B	—	Black
R-X110LB	with LW	Black

Contents

Safety Precautions	1-1	5. Block Diagram	1-9
1. Specifications	1-2	Parts List	Separate-volume Insertion
2. Names of Controls and Their Functions	1-3	6. R-X110/R-X110L Schematic Diagram	
3. Removal Procedures	1-5	6-(1) R-X110 Tuner Section	1-10
3-(1) Metal cover section	1-6	6-(2) R-X110L Tuner Section	1-11
3-(2) Front panel section	1-6	6-(3) R-X110/R-X110L Amplifier Section	1-12
3-(3) Chassis base section	1-6	6-(4) Internal Block Diagram of Major LSI ICs	1-13
4. FM/AM(MW/LW) Tuner Alignment Procedures	1-7		

1. Main Parts Locations

1-(1) Top View

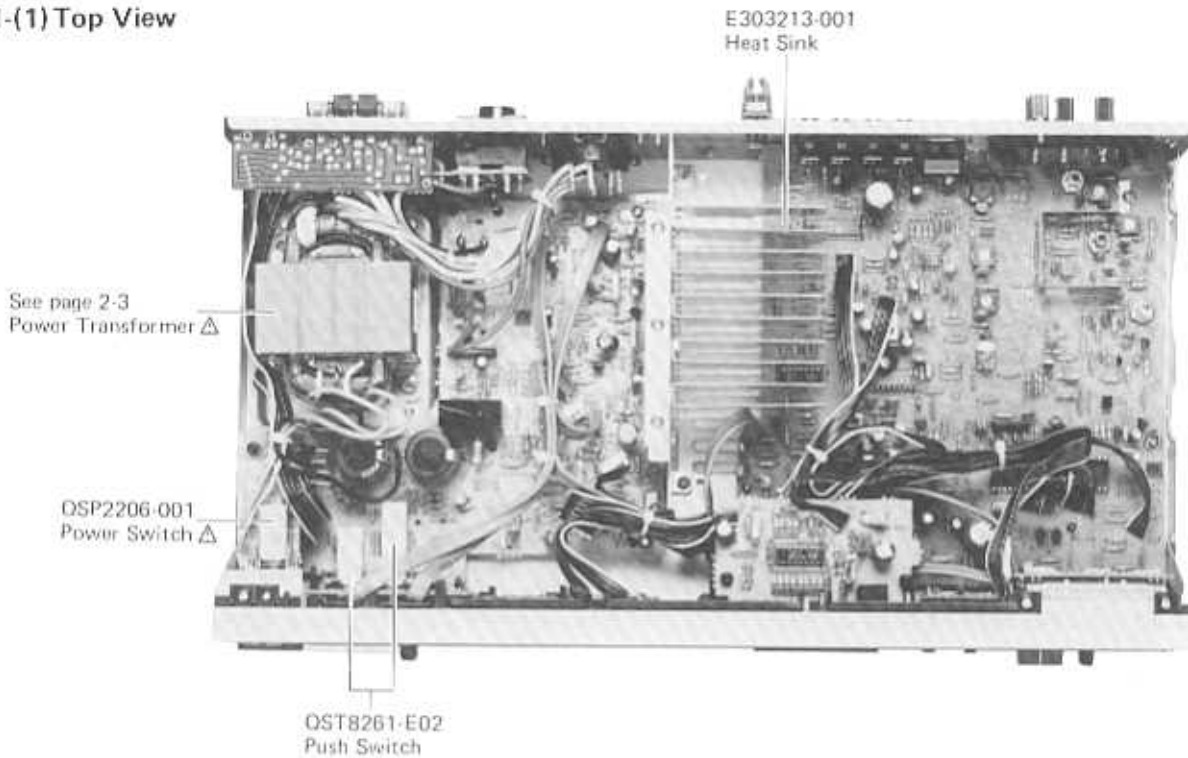

1-(2) Front View

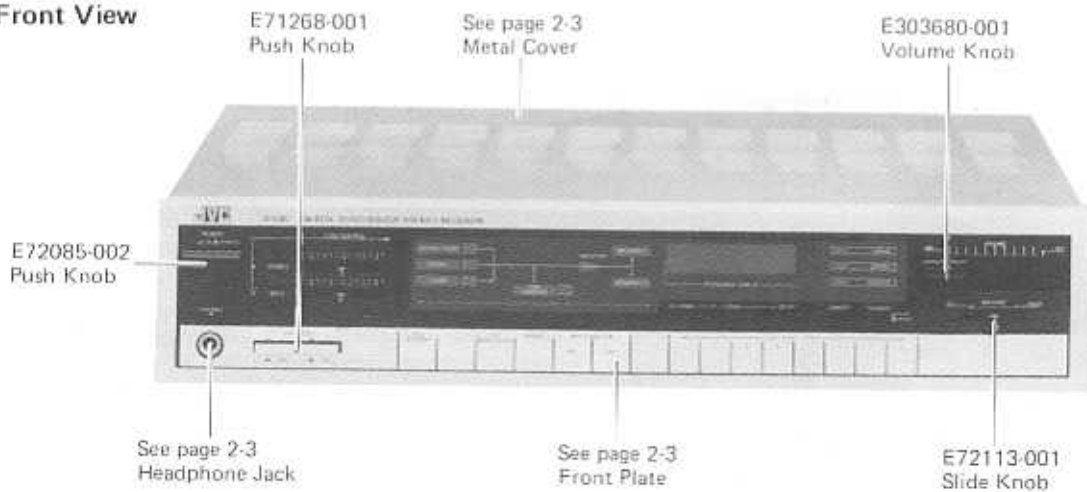

1-(3) Rear View

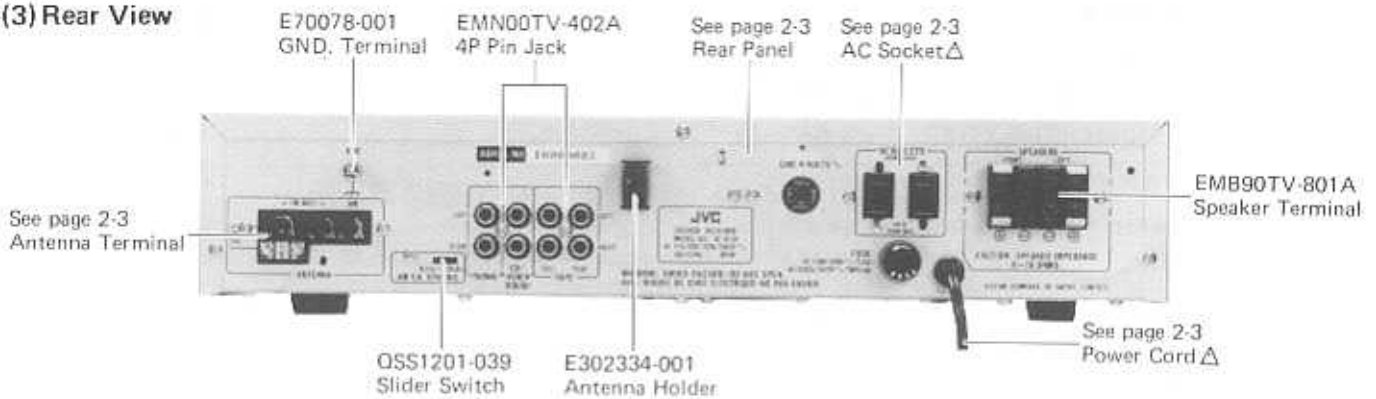

△	No.	Part Number	Part Name	Q'ty	Description	Areas
		E24944-004	Rear Panel	1	Silver	G
		E24944-008	Rear panel	1	Black	G
	35	E302334-001	Antenna Holder	1		
△	36	QMP1200-200	Power Cord	1		J
△		QMP1340-200	Power Cord	1		C
△		QMP3900-200	Power Cord	1		E, G, LE
△		QMP2560-244	Power Cord	1		A
△		QMP7600-200	Power Cord	1		U, P, PG
△		QMP9017-008BS	Power Cord	1		LBS
△	37	QHS3876-162	Cord Stopper	1		Except BS
△		QHS3876-162BS	Cord Stopper	1		BS only
	38	SDSB3008N	Screw	2		J, C, U, P, PG
	39	E303213-001	Heat Sink	1		
	40	STK4141MK2	Power Pac	1		
	41	E69589-006	Spacer	1		J only
△	42	QMC0437-002	2P AC Socket	1		J, U, P, PG
△		QMC0440-001	2P AC Socket	1		C
	43	EMB90TV-801A	Speaker Terminal	1		
	44	ESK5D24-218	Relay	1		
	45	QE20072-338	Electrolytic Capacitor	2		
	46	SBSB3008N	Screw	2		
	47	SBSE3008Z	Screw	2		
	48	SBST3006Z	Screw	1		
	49	QST8261-ED2	Push Switch	1		
	50	E48729-008	Plastic Rivet	1		
	51	QSP2206-001	Push Switch	1		
	52	QMS6302-125	Headphone Jack	1	Silver	
		QMS6302-128	Headphone Jack	1	Black	
	53	E72091-001	Bracket	1		
	54	E72085-002	Push Knob	1		
	55	E65389-002	Screw	4		
△	56	ETP1070-16JA	Power Transformer	1		J
△		ETP1070-16CA	Power Transformer	1		C
△		ETP1070-16FA	Power Transformer	1		U, P, PG
△		ETP1070-16EA	Power Transformer	1		E, G, A, LE
△		ETP1070-16EABS	Power Transformer	1		LBS
	57	E10949-003	Chassis Base	1		
	58	SBSB3008N	Screw	2		
	59	E301258-002	Foot	4		
	60	E303216-003	Fastener	3		

△: Safety Parts

The Marks for Designated Areas

J..... U.S.A.
 C..... Canada
 A..... Australia
 E, LE..... Europe
 G..... West Germany
 P, PG..... U.S. Military Market
 LBS..... U.K.
 U..... Other Countries

2. Exploded Views and Part Numbers

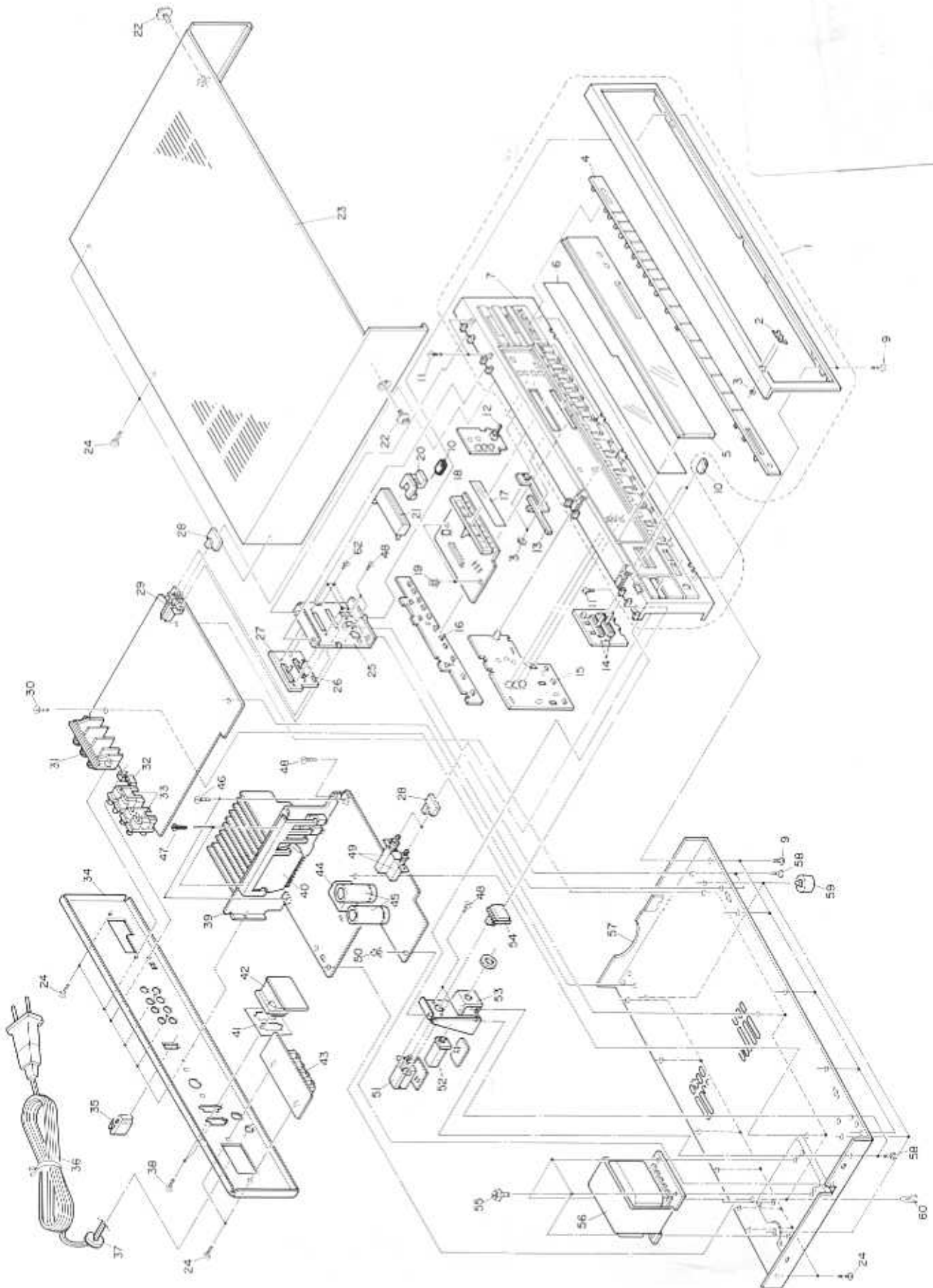

△	No.	Part Number	Part Name	Q'ty	Description	Areas
	1	EFP-RX110J	Front Panel Ass'y	1	Silver	J,C,P,PG,U
		EFP-RX110BJ	Front Panel Ass'y	1	Black	J,C,P,PG,U
		EFP-RX110E	Front Panel Ass'y	1	Silver	E,A,G
		EFP-RX110BE	Front Panel Ass'y	1	Black	E,A,G
		EFP-RX110LE	Front Panel Ass'y	1	Silver	LE,LBS
	2	EFP-RX110BLE	Front Panel Ass'y	1	Black	LE,LBS
		E70913-002	JVC Mark	1	Silver	
		E70913-001	JVC Mark	1	Black	
	3	E60912-003	Speed Nut	3		
	4	E24942-001	Front Plate	1	Silver	J,C,P,PG,U
		E24942-005	Front Plate	1	Black	J,C,P,PG,U
		E24942-002	Front Plate	1	Silver	E,A,G
		E24942-006	Front Plate	1	Black	E,A,G
		E24942-009	Front Plate	1	Silver	LE,LBS
		E24942-011	Front Plate	1	Black	LE,LBS
	5	E303676-001	Window Screen	1		
	6	E303678-001	Indicator Sheet	1		
	7	E11083-001	Front Base	1		Except LE,LBS
		E11083-002	Front Base	1		LE,LBS
	8	E24940-001	Front Panel	1	Silver	Except LE,LBS
		E24940-005	Front Panel	1	Black	Except LE,LBS
		E24940-002	Front Panel	1	Silver	LE,LBS
		E24940-006	Front Panel	1	Black	LE,LBS
	9	SBSF3008Z	Screw	7	Silver	
		SBSF3008M	Screw	7	Black	
	10	E72113-001	Slide Knob	3		
	11	SBSB3008N	Screw	3		
	12	E72089-001	Push Knob	1		
	13	E72090-001	Push Knob	1		
	14	QVUB01C-E15B	Variable Resistor	2		
	15	ESP0001-011	Push Switch	3		
	16	ESP0001-007	Push Switch	11		
	17	E69230-013	FL Screen	1		J,C
		E70561-014	FL Screen	1		Except J,C
	18	ELU0001-016	FL Tube	1		
	19	E48720-007	Plastic Rivet	2		
	20	E303680-001	Slide Knob	1		
	21	E303681-001	Volume Escucheon	1		
	22	E61660-001	Screw	2	Silver	
		E61660-004	Screw	2	Black	
	23	E24633-002	Metal Cover	1	Silver	
		E24633-003	Metal Cover	1	Black	
	24	SBSB3008N	Screw	3	Silver	
		SBSB3008M	Screw	3	Black	
	25	E72097-001	Bracket	1		
	26	QVWA01W-EF5C	Variable Resistor	1		
	27	QVUB01B-EF5B	Variable Resistor	1		
	28	E71268-001	Push Knob	2		E,A,G,LE,LBS
	29	QST8101-E02	Push Switch	1		E,A,G,LE,LBS
	30	SBST3006Z	Screw	1		
	31	E03572-016	Antenna Terminal	1		Except G
		EMBO1YV-201A	Antenna terminal	1		G only
	32	QSS1201-039	Slide Switch	1		U,P,PG
	33	EMN00TV-402A	4P Pin Jack	1		
	34	E24944-001	Rear Panel	1	Silver	J,C
		E24944-005	Rear Panel	1	Black	J,C
		E24944-002	Rear Panel	1	Silver	U,P,PG
		E24944-006	Rear Panel	1	Black	U,P,PG
		E24944-003	Rear Panel	1	Silver	E,A,LE,LBS
		E24944-007	Rear Panel	1	Black	E,A,LE,LBS

3. Printed Circuit Board Ass'y and Parts List

3-(1) ENA-038 □ Tuner P. C. Board Ass'y

Note: ENA-038 □ varies according to the areas employed. See note (1) when placing an order.

Note (1)

P.C. Board Ass'y	Designated Areas
ENA-038 [A]	U.S.A. & Canada
ENA-038 [B]	U.S. Military & Other Countries
ENA-038 [C]	Europe & Australia
ENA-038 [D]	Europe & U.K. with LW
ENA-038 [E]	West Germany

Note (2)

The symbols (赤, 黒, 白, ...) etc.) on P.C. Board surface are factory process only.

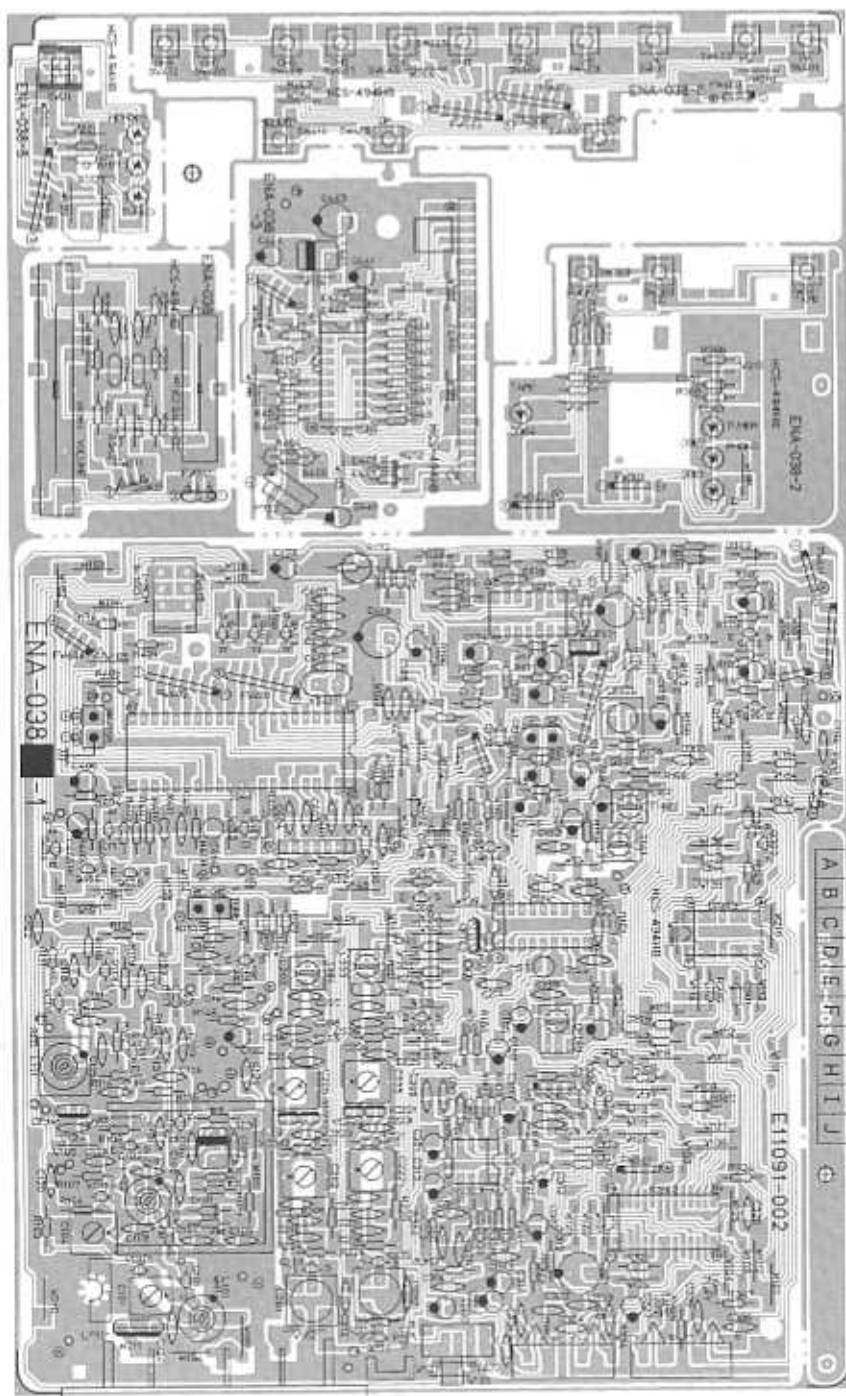

Transistors

Item	Part Number	Description	Area
Q101	2SK168(F)	F.E.T.	
Q102	2SC335(B,C)	Silicon	
Q111	2SC461(B,C)	Silicon	
Q112	2SK161(GR)	F.E.T.	
Q112	2SK161(GR)	F.E.T.	
Q112	2SK161(GR)	F.E.T.	
Q113	2SK161(GR)	F.E.T.	
Q142	2SC335(B,C)	Silicon	
Q143	2SC458(C,D)	Silicon	
Q144	2SK301(Q,R)	F.E.T.	
Q171	2SD655(E,F)	Silicon	
Q172	2SD655(E,F)	Silicon	
Q201	2SK301(Q,R)	F.E.T.	
Q202	2SK301(Q,R)	F.E.T.	
Q221	2SD655(E,F)	Silicon	
Q222	2SK301(Q,R)	F.E.T.	
Q223	2SK301(Q,R)	F.E.T.	
Q301	DTA144YN	Silicon	
Q302	DTA144YN	Silicon	
Q401	DTC144YN	Silicon	
Q402	DTC144YN	Silicon	
Q403	DTC144YN	Silicon	
Q404	DTA144YN	Silicon	
Q405	DTA144YN	Silicon	
Q406	DTA144YN	Silicon	
Q407	2SK301(Q)	F.E.T.	
Q408	2SC458(C,D)	Silicon	

ICs

Item	Part Number	Description	Area
IC141	AN7223		
IC171	LA3410		
IC301	NJMN055D-D		
IC302	LC7515H		
IC303	TC4016B		
IC401	TC9147BP		
IC402	TD6104P		
IC441	TC9158P		

Diodes

Item	Part Number	Description	Area
D101	1S2473	Silicon	
D141	1S2473	Silicon	
D142	1S2473	Silicon	
D143	1S2473	Silicon	
D171	1S2473	Silicon	
D172	1S2473	Silicon	
D173	1S2473	Silicon	
D174	1S2473	Silicon	
D175	1S2473	Silicon	
D176	1S2473	Silicon	
D177	1S2473	Silicon	
D201	1S2473	Silicon	
D221	1S2473	Silicon	
D301	1S2473	Silicon	
D302	1S2473	Silicon	
D303	1S2473	Silicon	
D304	1S2473	Silicon	
D306	RD2.7EB2	Zener	
D307	RD6.8EB3	Zener	
D351	1S2473	Silicon	
D351	SLR-55DC50F	L.E.D.	
D362	SLR-55DC50F	L.E.D.	
D363	SLR-55DC50F	L.E.D.	
D364	SLR-55VC50F	L.E.D.	
D401	1S2473	Silicon	
D402	1S2473	Silicon	
D421	SLR-55VC50F	L.E.D.	
D422	SLR-55VC50F	L.E.D.	
D423	SLR-55VC50F	L.E.D.	
D441	1S2473	Silicon	
D442	1S2473	Silicon	
D443	RD2.7EB2	Zener	
D444	RD2.7EB2	Zener	
VC101	SVC202(AB)	V.cap	
VC102	SVC202(AB)	V.cap	
VC111	SVC202(AB)	V.cap	
VC201	KV1236Z	V.cap	
VC202	KV1236Z	V.cap	
VC221	KV1236Z	V.cap	
VC222	KV1236Z	V.cap	

Coils

Item	Part Number	Description	Area
L101	BQR2304-005	OSC Coil	
L101	BQR2304-005	OSC Coil	
L101	BQR2304-005	OSC Coil	
L101	BQR2304-005	OSC Coil	
L101	BQR2304-004	RF Coil	
L102	BQR2304-006	RF Coil	
L103	SQL3001-1R5KY	RF Coil	
L111	BQR2404-004	RF Coil	
L201	BQR1111-005	RF Coil	
L202	BQR1307-004	LW OSC Coil	
L221	BQR1111-006	RF Coil	
L222	BQR1207-006	RF Coil	
L441	SQL3001-102KY	Inductor	

Capacitors

Item	Part Number	Description	Area
C101	QAT2001-001	Trimmer	
C102	QCF31HP-103	0.01MF 50V Ceramic	
C103	QCS31HJ-5R0	5.0pF 50V Ceramic	
C104	QAT2001-001	Trimmer	
C105	QCS31HJ-4R0	4.0pF 50V Ceramic	
C107	QCS31HJ-151	150pF 50V Ceramic	
C108	QCF31HP-103	0.01MF 50V Ceramic	
C109	QCF31HP-103	0.01MF 50V Ceramic	
C110	QCS31HJ-7R0	7.0pF 50V Ceramic	
C110	QCS31HJ-7R0	7.0pF 50V Ceramic	
C111	QCT250J-100	10pF 50V Ceramic	
C112	QCS31HJ-7R0	7.0pF 50V Ceramic	
C113	QCT250J-220	22pF 50V Ceramic	
C114	QCS31HJ-4R0	4.0pF 50V Ceramic	
C114	QCS31HJ-4R0	4.0pF 50V Ceramic	
C114	QCS31HJ-4R0	4.0pF 50V Ceramic	
C115	QCF31HP-103	0.01MF 50V Ceramic	
C116	QCT250J-100	10 50V Ceramic	
C117	QCF31HP-103	0.01MF 50V Ceramic	
C118	QCS31HJ-2R0	2.0pF 50V Ceramic	
C119	QCS31HJ-221	220pF 50V Ceramic	
C120	QCF31HP-223	0.022MF 50V Ceramic	
C121	QCS31HJ-3R0	3.0pF 50V Ceramic	
C121	QCS31HJ-3R0	3.0pF 50V Ceramic	
C123	QCF31HP-103	0.01MF 50V Ceramic	
C141	QCF31HP-223	0.022MF 50V Ceramic	
C144	QCF31HP-223	0.022MF 50V Ceramic	
C145	QET61EM-106	10MF 25V Electrolytic	
C146	QET61EM-476	47MF 10V Electrolytic	
C147	QET61EM-225	2.2MF 50V Electrolytic	
C148	QET61EM-476	47MF 16V Electrolytic	
C149	QCF31HP-223	0.022MF 50V Ceramic	
C150	QCF31HP-223	0.022MF 50V Ceramic	
C151	QET61EM-106	10MF 25V Electrolytic	
C152	QCS31HJ-271	270pF 50V Ceramic	
C152	QCS31HJ-271	270pF 50V Ceramic	
C152	QCS31HJ-151	150pF 50V Ceramic	
C152	QCS31HJ-151	150pF 50V Ceramic	
C152	QCS31HJ-151	150pF 50V Ceramic	
C153	QCF31HP-223	0.022MF 50V Ceramic	
C154	QCF31HP-223	0.022MF 50V Ceramic	
C155	QET61EM-476	47MF 16V Electrolytic	
C156	QET61EM-476	47MF 16V Electrolytic	
C157	QEN61EM-475	4.7MF 50V Non Pole	
C158	QET61EM-106	10MF 25V Electrolytic	
C159	QCF31HP-223	0.022MF 50V Ceramic	
C160	QCF31HP-223	0.022MF 50V Ceramic	
C161	QCS31HJ-101	100pF 50V Ceramic	
C171	QET61EM-105	1MF 50V Electrolytic	
C172	QET61EM-474	0.47MF 50V Electrolytic	
C173	QET61EM-106	10MF 25V Electrolytic	
C174	QET61EM-105	1MF 50V Electrolytic	
C175	QCS31HJ-821	820pF 50V Ceramic	
C175	QCS31HJ-821	820pF 50V Ceramic	
C175	QCS31HJ-681	680pF 50V Ceramic	
C175	QCS31HJ-681	680pF 50V Ceramic	
C175	QCS31HJ-681	680pF 50V Ceramic	
C176	QCS31HJ-821	820pF 50V Ceramic	
C176	QCS31HJ-821	820pF 50V Ceramic	
C176	QCS31HJ-821	820pF 50V Ceramic	
C176	QCS31HJ-681	680pF 50V Ceramic	
C176	QCS31HJ-681	680pF 50V Ceramic	
C176	QCS31HJ-681	680pF 50V Ceramic	
C177	QET61EM-107	100MF 16V Electrolytic	
C178	QET61EM-226	22MF 16V Electrolytic	
C179	QCF31HP-473	0.047MF 50V Ceramic	
C181	QET61EM-475	4.7MF 50V Electrolytic	
C182	QET61EM-475	4.7MF 50V Electrolytic	
C183	QCY31HX-222	2200pF 50V Ceramic	
C184	QCY31HX-222	2200pF 50V Ceramic	
C185	QET61EM-226	22MF 25V Electrolytic	
C186	QET61EM-226	22MF 25V Electrolytic	

Capacitors

Item	Part Number	Description	Area
C221	QCS31HJ-580	5.0pF 50V Ceramic	
C222	QAT2001-005	Trimmer	
C223	QCC31EM-473	0.047 25V Ceramic	
C224	QCF31HP-223	0.022MF 50V Ceramic	
C225	QAT2001-005	Trimmer	
C226	QCT25CH-150	15pF 50V Ceramic	
C227	QCS31HJ-270	27pF 50V Ceramic	
C228	QFP31HJ-471	470pF 50V Poly	
C231	QCF31HP-223	0.022MF 50V Ceramic	
C232	QCF31HP-223	0.022MF 50V Ceramic	
C301	QET61HM-475	4.7MF 50V Electrolytic	
C302	QET61HM-475	4.7MF 50V Electrolytic	
C305	QCY31HK-182	1800pF 50V Ceramic	
C306	QCY31HK-182	1800pF 50V Ceramic	
C307	QCY31HK-682	6800pF 50V Ceramic	
C308	QCY31HK-682	6800pF 50V Ceramic	
C309	QCS31HJ-560	56pF 50V Ceramic	A
C309	QCS31HJ-560	56pF 50V Ceramic	B
C309	QCS31HJ-560	56pF 50V Ceramic	C
C309	QCS31HJ-560	56pF 50V Ceramic	D
C309	QCS31HJ-331	330pF 50V Ceramic	E
C310	QCS31HJ-560	56pF 50V Ceramic	A
C310	QCS31HJ-560	56pF 50V Ceramic	B
C310	QCS31HJ-560	56pF 50V Ceramic	C
C310	QCS31HJ-560	56pF 50V Ceramic	D
C310	QCS31HJ-331	330pF 50V Ceramic	E
C311	QET61HM-475	4.7MF 50V Electrolytic	
C312	QET61HM-475	4.7MF 50V Electrolytic	
C313	QET61AM-476	47MF 10V Electrolytic	
C314	QET61AM-476	47MF 10V Electrolytic	
C321	QET61CM-226	22MF 16V Electrolytic	
C322	QET61CM-226	22MF 16V Electrolytic	
C323	QCF31HP-223	0.022MF 50V Ceramic	
C324	QCF31HP-223	0.022MF 50V Ceramic	
C325	QET51CM-106	1000mF 16V Electrolytic	
C326	QCF31HP-223	0.022MF 50V Ceramic	
C327	QET61HM-105	1MF 50V Electrolytic	
C328	QCS31HJ-101	100pF 50V Ceramic	
C329	QCS31HJ-101	100pF 50V Ceramic	
C330	QCF31HP-102	1000pF 50V Ceramic	
C331	QCS31HJ-331	330pF 50V Ceramic	E
C332	QCS31HJ-331	330pF 50V Ceramic	E
C333	QCS31HJ-331	330pF 50V Ceramic	E
C334	QCS31HJ-331	330pF 50V Ceramic	E
C335	QCS31HJ-331	330pF 50V Ceramic	E
C336	QCS31HJ-331	330pF 50V Ceramic	E
C351	QCS31HJ-181	180pF 50V Ceramic	
C352	QCS31HJ-181	180pF 50V Ceramic	
C353	QFN31HK-183	0.018MF 50V Mylar	
C354	QFN31HK-183	0.018 50V Mylar	
C401	QCF31HP-103	0.01MF 50V Ceramic	
C402	QCF31HP-103	0.01MF 50V Ceramic	
C403	QCF31HP-103	0.01MF 50V Ceramic	
C404	QCF31HP-103	0.01MF 50V Ceramic	
C405	QET61HM-105	1MF 50V Electrolytic	
C406	QET61HM-105	1MF 50V Electrolytic	
C407	QCF31HP-103	0.01MF 50V Ceramic	D
C408	QCF31HP-102	1000pF 50V Ceramic	
C409	QCF31HP-102	1000pF 50V Ceramic	
C410	QCS31HJ-100	10pF 50V Ceramic	
C411	QCS31HJ-100	10pF 50V Ceramic	
C412	QCF31HP-103	0.01MF 50V Ceramic	
C413	QET50JH-226	2200MF 6.3V Electrolytic	
C414	QEN61HM-225	2.2MF 50V Non Pole	A
C414	QEN61HM-225	2.2MF 50V Non Pole	B
C414	QEN61HM-225	2.2MF 50V Non Pole	C
C414	QEN61HM-225	2.2MF 50V Non Pole	D
C414	QEN61HM-474	0.47 50V Non Pole	D
C414	QEN61HM-225	2.2MF 50V Non Pole	E
C415	QCS31HJ-101	100pF 50V Ceramic	A
C415	QCS31HJ-101	100pF 50V Ceramic	B
C415	QCS31HJ-101	100pF 50V Ceramic	C
C415	QCS31HJ-101	100pF 50V Ceramic	E
C415	QCY31HK-821	820pF 50V Ceramic	D
C441	QET61EM-106	10MF 25V Electrolytic	
C442	QCF31HP-472	47000pF 50V Ceramic	
C443	QET50JH-477	470MF 6.3V Ceramic	
C444	QET61AM-476	47MF 10V Electrolytic	
C445	QET61HM-476	47MF 50V Electrolytic	

Resistors

Item	Part Number	Description	Area
R102	QRD141J-2203	22 1/4W Carbon	
R103	QRD141J-4733	47K 1/4W Carbon	
R104	QRD141J-4733	47K 1/4W Carbon	
R105	QRD141J-3923	3.9K 1/4W Carbon	
R106	QRD141J-2233	22K 1/4W Carbon	
R107	QRD141J-1023	1K 1/4W Carbon	
R108	QRD141J-5613	560 1/4W Carbon	
R109	QRD141J-2213	220 1/4W Carbon	
R111	QRD141J-4723	4.7K 1/4W Carbon	
R112	QRD141J-6823	.68K 1/4W Carbon	
R113	QRD141J-1033	10K 1/4W Carbon	
R114	QRD141J-1223	1.2K 1/4W Carbon	
R115	QRD141J-3313	330 1/4W Carbon	
R115	QRD141J-3313	330 1/4W Carbon	C
R115	QRD141J-3313	330 1/4W Carbon	D
R115	QRD141J-3313	330 1/4W Carbon	E
R116	QRD141J-1043	100K 1/4W Carbon	C
R116	QRD141J-1043	100K 1/4W Carbon	D
R116	QRD141J-1043	100K 1/4W Carbon	E
R117	QRD141J-1213	120 1/4W Carbon	
R118	QRD141J-1043	100K 1/4W Carbon	
R119	QRD141J-4713	470 1/4W Carbon	
R120	QRD145J-3303	33 UNF, Carbon	
R121	QRD141J-2223	2.2K 1/4W Carbon	
R142	QRD145J-3303	33 UNF, Carbon	
R147	QRD141J-1033	10K 1/4W Carbon	
R148	QRD141J-6823	6.8K 1/4W Carbon	
R150	QRD141J-5613	560 1/4W Carbon	
R151	QRD141J-1023	1K 1/4W Carbon	
R153	QRD141J-8213	820 1/4W Carbon	
R154	QRD141J-8223	82K 1/4W Carbon	
R155	QRD141J-1533	15K 1/4W Carbon	
R156	QRD141J-4733	47K 1/4W Carbon	
R157	QRD141J-11023	1K 1/4W Carbon	
R158	QRD141J-2723	2.7K 1/4W Carbon	
R160	QRD141J-3313	330 1/4W Carbon	
R161	QRD141J-1533	15K 1/4W Carbon	
R162	QRD141J-1043	100K 1/4W Carbon	
R163	QRD141J-1023	1K 1/4W Carbon	
R164	QRD141J-4713	470 1/4W Carbon	
R165	QRD141J-4713	470 1/4W Carbon	
R171	QRD141J-1023	1K 1/4W Carbon	
R172	QRD141J-8233	82K 1/4W Carbon	A
R172	QRD141J-8233	82K 1/4W Carbon	B
R172	QVZ3518-224	220K Variable	C
R172	QVZ3518-224	220K Variable	D
R172	QVZ3518-224	220K Variable	E
R173	QRD141J-4723	4.7K 1/4W Carbon	
R174	QRD145J-6803	68 UNF, Carbon	A
R174	QRD145J-6803	68 UNF, Carbon	B
R174	QRZ0062-680	68 Fusible	C
R174	QRZ0062-680	68 Fusible	D
R174	QRZ0062-680	68 Fusible	E
R175	QRD141J-8233	82K 1/4W Carbon	
R176	QRD141J-8233	82K 1/4W Carbon	
R179	QRD141J-3323	3.3K 1/4W Carbon	
R180	QRD141J-3323	3.3K 1/4W Carbon	
R181	QRD141J-1033	10K 1/4W Carbon	
R182	QRD141J-1033	10K 1/4W Carbon	
R183	QRD141J-6823	6.8K 1/4W Carbon	
R184	QRD141J-6823	6.8K 1/4W Carbon	
R185	QRD141J-6813	680 1/4W Carbon	
R186	QRD141J-1033	10K 1/4W Carbon	
R187	QRD141J-1033	10K 1/4W Carbon	
R188	QRD141J-2733	27K 1/4W Carbon	
R189	QRD141J-2733	27K 1/4W Carbon	
R201	QRD141J-1033	10K 1/4W Carbon	D
R203	QRD141J-1043	100K 1/4W Carbon	D
R204	QRD141J-4713	470 1/4W Carbon	D
R205	QRD141J-1033	10K 1/4W Carbon	D
R206	QRD141J-1033	10K 1/4W Carbon	D
R207	QRD141J-1033	10K 1/4W Carbon	D
R208	QRD141J-3313	330 1/4W Carbon	D
R209	QRD141J-4723	4.7K 1/4W Carbon	D
R221	QRD141J-1033	10K 1/4W Carbon	
R223	QRD141J-1043	100K 1/4W Carbon	
R224	QRD141J-4713	470 1/4W Carbon	
R225	QRD141J-1033	10K 1/4W Carbon	
R226	QRD141J-1033	10K 1/4W Carbon	D
R227	QRD141J-3313	330 1/4W Carbon	
R301	QRD141J-2223	2.2K 1/4W Carbon	
R302	QRD141J-2223	2.2K 1/4W Carbon	
R303	QRD141J-4733	47K 1/4W Carbon	
R304	QRD141J-4733	47K 1/4W Carbon	
R305	QRD141J-8213	820 1/4W Carbon	
R306	QRD141J-8213	820 1/4W Carbon	
R307	QRD141J-3933	39K 1/4W Carbon	
R308	QRD141J-3933	39K 1/4W Carbon	

▲ Safety parts

Resistors

Item	Part Number	Description	Area
R309	QRD141J-474S	470K 1/4W Carbon	
R310	QRD141J-474S	470K 1/4W Carbon	
R311	QRD141J-104S	100K 1/4W Carbon	
R312	QRD141J-104S	100K 1/4W Carbon	
R321	QRD141J-181S	180 1/4W Carbon	
R322	QRD141J-101S	100 1/4W Carbon	
R323	QRD141J-473S	47K 1/4W Carbon	
R324	QRD141J-225S	2.2M 1/4W Carbon	
R325	QRD141J-104S	100K 1/4W Carbon	
R326	QRD141J-103S	10K 1/4W Carbon	
R327	QRD141J-104S	100K 1/4W Carbon	
R329	QRD141J-103S	10K 1/4W Carbon	
R330	QRD141J-103S	10K 1/4W Carbon	
R331	QRD141J-103S	10K 1/4W Carbon	
R332	QRD145J-470S	47 1/4W UNF. Carbon	C
R332	QRD145J-470S	47 1/4W UNF. Carbon	D
R332	QRD145J-470S	47 1/4W UNF. Carbon	E
R341	QRD141J-332S	3.3K 1/4W Carbon	
R342	QRD141J-332S	3.3K 1/4W Carbon	
R343	QRD141J-103S	10K 1/4W Carbon	
R344	QRD141J-104S	100K 1/4W Carbon	
R346	QRD141J-103S	10K 1/4W Carbon	
R347	QRD141J-474S	470S 1/4W Carbon	
R348	QRD141J-474S	470K 1/4W Carbon	
R351	QRD141J-223S	22K 1/4W Carbon	
R352	QRD141J-223S	22K 1/4W Carbon	
R353	QRD141J-683S	68K 1/4W Carbon	
R354	QRD141J-683S	68K 1/4W Carbon	
R361	QRD141J-222S	2.2K 1/4W Carbon	
R362	QRD141J-152S	1.5K 1/4W Carbon	
R365	QRD141J-152S	1.5K 1/4W Carbon	
R401	QRD141J-104S	100K 1/4W Carbon	
R402	QRD141J-823S	82K 1/4W Carbon	
R403	QRD141J-683S	68K 1/4W Carbon	
R404	QRD141J-683S	68K 1/4W Carbon	
R405	QRD141J-472S	4.7K 1/4W Carbon	A
R406	QRD141J-102S	1K 1/4W Carbon	
R407	QRD141J-222S	2.2K 1/4W Carbon	
R408	QRD141J-152S	1.5K 1/4W Carbon	A
R408	QRD141J-152S	1.5K 1/4W Carbon	B
R408	QRD141J-152S	1.5K 1/4W Carbon	C
R408	QRD141J-152S	1.5K 1/4W Carbon	E
R408	QRD141J-682S	6.8K 1/4W Carbon	D
R409	QRD141J-271S	270 1/4W Carbon	
R410	QRD141J-103S	10K 1/4W Carbon	
R411	QRD141J-472S	4.7K 1/4W Carbon	
R412	QRD141J-151S	150 1/4W Carbon	
R421	QRD141J-472S	4.7K 1/4W Carbon	C
R421	QRD141J-472S	4.7K 1/4W Carbon	D
R421	QRD141J-472S	4.7K 1/4W Carbon	E
R423	QRD141J-222S	2.2K 1/4W Carbon	
R441	QRD141J-104S	100K 1/4W Carbon	
R442	QRD141J-104S	100K 1/4W Carbon	
R443	QRD141J-104S	100K 1/4W Carbon	
R444	QRD141J-104S	100K 1/4W Carbon	
R445	QRD141J-104S	100K 1/4W Carbon	
R446	QRD141J-104S	100K 1/4W Carbon	
R448	QRD141J-104S	100K 1/4W Carbon	
R449	QRD141J-104S	100K 1/4W Carbon	
R450	QRD141J-104S	100K 1/4W Carbon	
R451	QRD141J-104S	100K 1/4W Carbon	
R452	QRD141J-104S	100K 1/4W Carbon	
R453	QRD141J-223S	22K 1/4W Carbon	
R454	QRG022J-331AM	330 2W O.M.Film	A
R454	QRG022J-331AM	330 2W O.M.Film	B
R454	QRG022J-331AM	330 2W O.M.Film	C
R454	QRG022J-331AF	330 2W O.M.Film	D
R454	QRG022J-331AF	330 2W O.M.Film	E
R455	QRD141J-222S	2.2K 1/4W Carbon	
VR351	QVUB01B-EP5B	Variable	
VR352	QVWA01W-EP5C	Variable	

△ Safety parts

Others

Item	Part Number	Description	Area
	E11091-002	Circuit Board	
	E03572-016	Antenna Terminal	A
	E03572-016	Antenna Terminal	B
	E03572-016	Antenna Terminal	C
	E03572-016	Antenna Terminal	D
	EMB01TV-201A	Antenna Terminal	E
	E70225-001	Earth Plate	
	E72108-001	Shield Case	
	E70859-001	Earth Plate	
	EMN00TV-402A	HP Pin Jack	
	EMN00TV-402A	HP Pin Jack	
	E04365-003	FW.Socket	
	E67764-002	Terminal Assy	
	E67910-001	Spacer	
	E65654-001	Spacer	C
	E65654-001	Spacer	D
	E65654-001	Spacer	E
P702	E04365-003	F.W.Socket	
LF101	EQP0201-004	Filter	E
LF171	EQP0102-001	Filter	E
T141	EQE2140-010	I.F.T.	
CF141	ECB2123-001B	Ceramic Filter	A
CF141	ECB2123-001B	Ceramic Filter	B
CF141	ECB2118-001B	Ceramic Filter	C
CF141	ECB2118-001B	Ceramic Filter	D
CF142	ECB2118-001B	Ceramic Filter	E
CF142	ECB2123-001B	Ceramic Filter	A
CF142	ECB2123-001B	Ceramic Filter	B
CF142	ECB2118-001B	Ceramic Filter	C
CF142	ECB2118-001B	Ceramic Filter	D
CF142	ECB2118-001B	Ceramic Filter	E
CF143	ECB1560-001	Ceramic Filter	
CF171	ECX0000-456K3	Resonator	
XF401	QCX0007-200KC	X'tal	
FL441	ELU0001-016	FL Tube	
SW301	ESP0001-011	Push Switch	
SW302	ESP0001-011	Push Switch	
SW303	ESP0001-011	Push Switch	
SW421	GSP2256-001	Push Switch	
SW422	QSS1201-039	Push Switch	B
SW401	ESP0001-007	Push Switch	
SW402	ESP0001-007	Push Switch	
SW403	ESP0001-007	Push Switch	
SW404	ESP0001-007	Push Switch	
SW405	ESP0001-007	Push Switch	
SW406	ESP0001-007	Push Switch	
SW407	ESP0001-007	Push Switch	
SW408	ESP0001-007	Push Switch	
SW409	ESP0001-007	Push Switch	
SW410	ESP0001-007	Push Switch	
SW411	ESP0001-007	Push Switch	D
SW412	ESP0001-007	Push Switch	
SW413	ESP0001-007	Push Switch	
SW414	ESP0001-007	Push Switch	
SW415	QST6101-802	Push Switch	C
SW415	QST6101-802	Push Switch	D
SW415	QST6101-802	Push Switch	E

3-(2) ENH-055 □ Audio P. C. Board Ass'y

Note: ENH-055 □ varies according to the areas employed. See note (1) when placing an order.

Note (1)

P.C. Board Ass'y	Designated Areas
ENH-055 [A] or [H]	U.S.A.
ENH-055 [B] or [I]	Canada
ENH-055 [C] or [J]	U.S. Military Market & Other countries
ENH-055 [D] or [K]	Europe
ENH-055 [EBS] or [LBS]	U.K.
ENH-055 [F] or [M]	West Germany
ENH-055 [G] or [N]	Australia

Note (2)

They symbols (赤、黒、白etc.) on P.C. Board surface are factory process only.

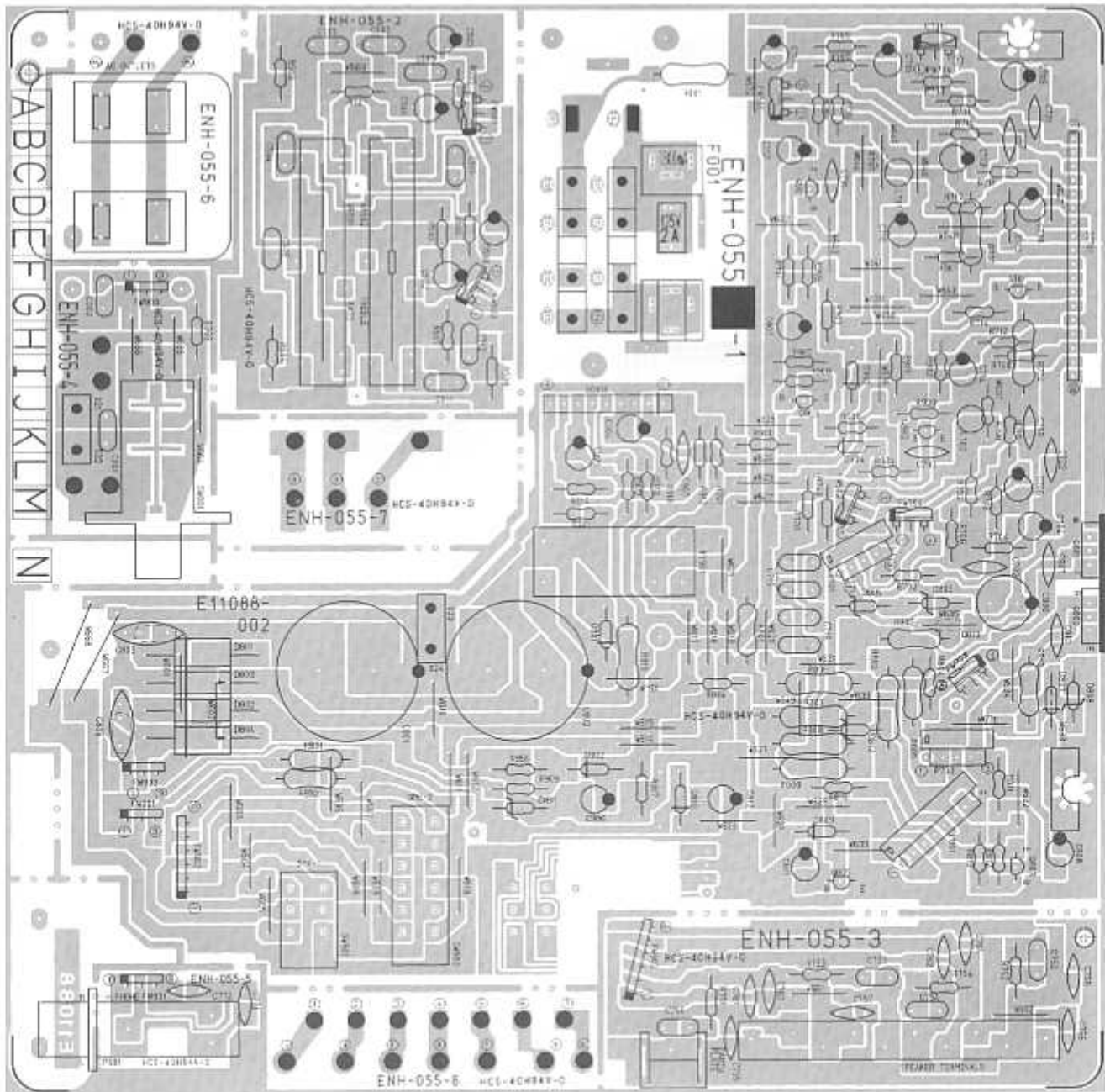

Transistors

Item	Part Number	Description	Area
Q701	2SC945A(P,Q)	Silicon	EBS
Q801	2SB941A(P,Q)	Silicon	
Q802	2SD1265A(D,F)	Silicon	
Q803	2SC2235(O,Y)	Silicon	
Q805	2SC458(C,D)	Silicon	
Q901	2SC1775AV(E,F)	Silicon	EBS
Q902	2SC1775AV(E,F)	Silicon	
Q903	2SA733A(P,Q)	Silicon	

ICs

Item	Part Number	Description	Area
IC701	STK4141MK2	Maker	F
IC901	TA731TP	Sanyo Tooshiba	

△ Safety parts

Diodes

Item	Part Number	Description	Area
D801	S3V20F	Silicon	EBS
D802	S3V20F	Silicon	
D803	S3V20F	Silicon	
D804	S3V20F	Silicon	
D805	RD13EB3	Zener	
D806	RD13EB3	Zener	EBS
D807	1S2473	Silicon	
D807	1S2473	Silicon	
D807	1S2473	Silicon	EBS
D807	1S2473	Silicon	
D808	RD12EB3	Zener	EBS
D810	1S2473	Silicon	
D811	RD5.1EB2	Zener	
D812	RD9.1EB3	Zener	EBS
D813	1S2473	Silicon	
D813	1S2473	Silicon	EBS
D813	1S2473	Silicon	
D813	1S2473	Silicon	EBS
D901	1S2473	Silicon	
D902	1S2473	Silicon	EBS
D903	1S2743	Silicon	
D904	1S2743	Silicon	

△ Safety parts

Capacitors

Item	Part Number	Description	Area
C001	QPM32AK-104	0.1MF 100V Mylar	EBS
C001	QPM32AK-104	0.1MF 100V Mylar	
C501	QET61HM-105	1MF 50V Electrolytic	EBS
C502	QET61HM-105	1MF 50V Electrolytic	
C503	QFN31HK-153	0.015MF 50V Mylar	
C504	QFN31HK-153	0.015MF 50V Mylar	
C505	QFN31HK-823	0.082MF 50V Mylar	
C506	QFN31HK-823	0.082MF 50V Mylar	
C507	QET61HM-105	1MF 50V Electrolytic	
C508	QET61HM-105	1MF 50V Electrolytic	
C509	QFN31HK-332	3300pF 50V Mylar	EBS
C510	QFN31HK-332	3300pF 50V Mylar	
C511	QFN31HK-183	0.018MF 50V Mylar	
C512	QFN31HK-183	0.018MF 50V Mylar	
C701	QCS31HJ-680	68pF 50V Ceramic	
C702	QCS31HJ-680	68pF 50V Ceramic	
C703	QET61HM-225	2.2MF 50V Electrolytic	
C704	QEH61HM-225	2.2MF 50V Electrolytic	
C705	QET61AM-476	47MF 10V Electrolytic	
C706	QEH61AM-476	47MF 10V Electrolytic	
C707	QCS31HJ-100	10pF 50V Ceramic	
C708	QCS31HJ-100	10pF 50V Ceramic	
C709	QEH61HM-106	10MF 50V Electrolytic	
C710	QET61HM-106	10MF 50V Electrolytic	
C711	QETC1HM-475	4.7MF 50V Electrolytic	
C712	QETC1HM-475	4.7MF 50V Electrolytic	
C713	QET61HM-476	47MF 50V Electrolytic	
C714	QET61HM-476	47MF 50V Electrolytic	
C715	QFN31HK-473	0.047MF 50V Mylar	
C716	QFN31HK-473	0.047MF 50V Mylar	

Capacitors

Item	Part Number	Description	Area
C717	QFN31HK-473	0.047MF 50V Mylar	EBS
C717	QFN31HK-473	0.047MF 50V Mylar	
C717	QFN31HK-473	0.047MF 50V Mylar	EBS
C717	QFN31HK-473	0.047MF 50V Mylar	
C718	QFN31HK-473	0.047MF 50V Mylar	EBS
C718	QFN31HK-473	0.047MF 50V Mylar	
C718	QFN31HK-473	0.047MF 50V Mylar	EBS
C718	QFN31HK-473	0.047MF 50V Mylar	
C718	QFN31HK-473	0.047MF 50V Mylar	EBS
C718	QFN31HK-473	0.047MF 50V Mylar	
C721	QCS31HJ-221	220pF 50V Ceramic	EBS
C722	QCS31HJ-221	220pF 50V Ceramic	
C751	QFN31HK-473	0.047MF 50V Mylar	EBS
C752	QFN31HK-473	0.047MF 50V Mylar	
C753	QFN31HK-473	0.047MF 50V Mylar	EBS
C754	QFN31HK-473	0.047MF 50V Mylar	
C755	QCS31HJ-331	330pF 50V Ceramic	EBS
C756	QCS31HJ-331	330pF 50V Ceramic	
C757	QCS31HJ-331	330pF 50V Ceramic	EBS
C758	QCS31HJ-331	330pF 50V Ceramic	
C761	QCS31HJ-101	100pF 50V Ceramic	EBS
C762	QCS31HJ-101	100pF 50V Ceramic	
C763	QCS31HJ-101	100pF 50V Ceramic	EBS
C764	QCS31HJ-101	100pF 50V Ceramic	
C771	QCS31HJ-101	100pF 50V Ceramic	EBS
C772	QCS31HJ-101	100pF 50V Ceramic	
C801	QE20072-338	3300MF Electrolytic	EBS
C802	QE20072-338	3300MF Electrolytic	
C803	QPM32AK-473	0.047 100V Mylar	EBS
C803	QPM32AK-473	0.047 100V Mylar	
C803	QPM32AK-473	0.047 100V Mylar	EBS
C803	QPM32AK-473	0.047 100V Mylar	
C803	QPM32AK-473	0.047 100V Mylar	EBS
C803	QPM32AK-473	0.047 100V Mylar	
C803	QPM32AK-473	0.047 100V Mylar	EBS
C803	QPM32AK-473	0.047 100V Mylar	
C805	QPM32AK-473	0.047 100V Mylar	EBS
C805	QPM32AK-473	0.047 100V Mylar	
C805	QPM32AK-473	0.047 100V Mylar	EBS
C805	QPM32AK-473	0.047 100V Mylar	
C805	QPM32AK-473	0.047 100V Mylar	EBS
C805	QPM32AK-473	0.047 100V Mylar	
C805	QPM32AK-473	0.047 100V Mylar	EBS
C805	QPM32AK-473	0.047 100V Mylar	
C806	QRH51VM-107	100MF 35V Electrolytic	EBS
C807	QCF31HP-103	0.01MF 50V Ceramic	
C808	QETC1HM-107	100MF 35V Electrolytic	EBS
C811	QETC1HM-475	4.7MF 50V Electrolytic	
C812	QETC1CM-476	47MF 16V Electrolytic	EBS
C813	QCF31HP-103	0.01MF 50V Ceramic	
C903	QETC1HM-226	22MF 50V Electrolytic	EBS
C904	QETC1AM-107	100MF 10V Electrolytic	
C905	QETC1CM-226	22MF 16V Electrolytic	EBS
C906	QETC1HM-105	1MF 50V Electrolytic	

Resistors

Item	Part Number	Description	Area
R001	QRC128K-275EM	2.7M 1/2W Compos	EBS
R001	QRC128K-275EM	2.7M 1/2W Compos	
R501	QRD141J-203S	20K 1/4W Carbon	EBS
R502	QRD141J-203S	20K 1/4W Carbon	
R503	QRD141J-362S	3.6K 1/4W Carbon	
R504	QRD141J-362S	3.6K 1/4W Carbon	
R505	QRD141J-472S	4.7K 1/4W Carbon	
R506	QRD141J-472S	4.7K 1/4W Carbon	
R507	QRD141J-821S	820 1/4W Carbon	
R508	QRD141J-821S	820 1/4W Carbon	
R701	QRD141J-222S	2.2K 1/4W Carbon	
R702	QRD141J-222S	2.2K 1/4W Carbon	
R703	QRD141J-104S	100K 1/4W Carbon	
R704	QRD141J-104S	100K 1/4W Carbon	
R705	QRD141J-821S	820 1/4W Carbon	
R706	QRD141J-821S	820 1/4W Carbon	
R707	QRD141J-133S	13K 1/4W Carbon	
R708	QRD141J-133S	13K 1/4W Carbon	
R709	QRD141J-823S	82K 1/4W Carbon	
R710	QRD141J-823S	82K 1/4W Carbon	
R711	QRD145J-222S	2.2K 1/4W UNF. Carbon	EBS
R711	QRD145J-222S	2.2K 1/4W UNF. Carbon	
R711	QRD145J-222S	2.2K 1/4W UNF. Carbon	EBS
R711	QRD145J-222S	2.2K 1/4W UNF. Carbon	
R711	QRD141J-222S	2.2K 1/4W Carbon	EBS
R711	QRD141J-222S	2.2K 1/4W Carbon	
R711	QRD141J-222S	2.2K 1/4W Carbon	EBS
R711	QRD141J-222S	2.2K 1/4W Carbon	
R712	QRD145J-222S	2.2K 1/4W UNF. Carbon	EBS
R712	QRD145J-222S	2.2K 1/4W UNF. Carbon	

△ Safety Parts

Resistors

Item	Part Number	Description	Area	
△	R712	QRD145J-222S	2.2K 1/4W UNF. Carbon	G
△	R712	QRD141J-222S	2.2K 1/4W Carbon	A
△	R712	QRD141J-222S	2.2K 1/4W Carbon	B
△	R712	QRD141J-222S	2.2K 1/4W Carbon	C
△	R713	QRD141J-102S	1K 1/4W Carbon	C
△	R714	QRD141J-272S	2.7K 1/4W Carbon	D
△	R715	QRD145J-222S	2.2K 1/4W UNF. Carbon	D
△	R715	QRD145J-222S	2.2K 1/4W UNF. Carbon	EBS
△	R715	QRD145J-222S	2.2K 1/4W UNF. Carbon	F
△	R715	QRD145J-222S	2.2K 1/4W UNF. Carbon	G
△	R715	QRD141J-222S	2.2K 1/4W Carbon	A
△	R715	QRD141J-222S	2.2K 1/4W Carbon	B
△	R715	QRD141J-222S	2.2K 1/4W Carbon	C
△	R716	QRD145J-222S	2.2K 1/4W UNF. Carbon	D
△	R716	QRD145J-222S	2.2K 1/4W UNF. Carbon	EBS
△	R716	QRD145J-222S	2.2K 1/4W UNF. Carbon	F
△	R716	QRD145J-222S	2.2K 1/4W UNF. Carbon	G
△	R716	QRD141J-222S	2.2K 1/4W Carbon	A
△	R716	QRD141J-222S	2.2K 1/4W Carbon	B
△	R716	QRD141J-222S	2.2K 1/4W Carbon	C
△	R717	QRD141J-272S	2.7K 1/4W Carbon	D
△	R733	QRX022J-R22AM	0.22 2W O.M. Film	EBS
△	R734	QRX022J-R22AM	0.22 2W O.M. Film	F
△	R739	QRD145J-330S	33 1/4W UNF. Carbon	G
△	R740	QRD145J-330S	33 1/4W UNF. Carbon	G
△	R751	QRZ0062-100	10 1/4W Fusible	F
△	R752	QRZ0062-100	10 1/4W Fusible	F
△	R753	QRZ0062-100	10 1/4W Fusible	F
△	R754	QRZ0062-100	10 1/4W Fusible	F
△	R760	QRD145J-487S	4.7 1/4W UNF. Carbon	D
△	R797	QRD145J-470S	47 1/4W UNF. Carbon	D
△	R798	QRD145J-470S	47 1/4W UNF. Carbon	D
△	R801	QRD125J-282	2.2 1/2W UNF. Carbon	EBS
△	R802	QRD125J-122	1.2K 1/2W UNF. Carbon	F
△	R803	QRD022J-471AM	470 2W O.M. Film	G
△	R804	QRZ0062-150	15 1/4W Fusible	D
△	R804	QRZ0062-150	15 1/4W Fusible	EBS
△	R804	QRZ0062-150	15 1/4W Fusible	F
△	R804	QRZ0062-150	15 1/4W Fusible	G
△	R804	QRD145J-150S	15 1/4W UNF. Carbon	A
△	R804	QRD145J-150S	15 1/4W UNF. Carbon	B
△	R804	QRD145J-150S	15 1/4W UNF. Carbon	C
△	R806	QRG022J-101AM	100 2W O.M. Film	D
△	R806	QRG022J-101AM	100 2W O.M. Film	EBS
△	R806	QRG022J-101AM	100 2W O.M. Film	F
△	R806	QRG022J-101AM	100 2W O.M. Film	G
△	R806	QRG026J-101AF	100 2W O.M. Film	A
△	R806	QRG026J-101AF	100 2W O.M. Film	B
△	R806	QRG026J-101AF	100 2W O.M. Film	C
△	R806	QRG026J-101AF	100 2W O.M. Film	D
△	R806	QRG026J-101AF	100 2W O.M. Film	EBS
△	R806	QRG026J-101AF	100 2W O.M. Film	F
△	R806	QRG026J-101AF	100 2W O.M. Film	G
△	R807	QRG022J-101AM	100 2W O.M. Film	A
△	R807	QRG022J-101AM	100 2W O.M. Film	B
△	R807	QRG022J-101AM	100 2W O.M. Film	C
△	R807	QRG026J-101AF	100 2W O.M. Film	D
△	R807	QRG026J-101AF	100 2W O.M. Film	EBS
△	R807	QRG026J-101AF	100 2W O.M. Film	F
△	R807	QRG026J-101AF	100 2W O.M. Film	G
△	R810	QRD145J-182S	1.8K 1/4W UNF. Carbon	D
△	R811	QRD145J-680S	68 1/4W UNF. Carbon	D
△	R812	QRD141J-122S	1.2K 1/4W Carbon	B
△	R813	QRD141J-122S	1.2K 1/4W Carbon	B
△	R814	QRD141J-563S	56K 1/4W Carbon	B
△	R816	QRD141J-473S	47K 1/4W Carbon	B
△	R901	QRD141J-152S	1.5K 1/4W Carbon	B
△	R902	QRD141J-152S	1.5K 1/4W Carbon	B
△	R903	QRD141J-562S	5.6K 1/4W Carbon	B
△	R904	QRD141J-562S	5.6K 1/4W Carbon	B
△	R905	QRD141J-123S	12K 1/4W Carbon	B
△	R906	QRD141J-123S	12K 1/4W Carbon	B
△	R907	QRD141J-103S	10K 1/4W Carbon	B
△	R908	QRD141J-332S	3.3K 1/4W Carbon	B
△	R909	QRD141J-472S	4.7K 1/4W Carbon	B
△	R910	QRD141J-563S	56K 1/4W Carbon	B
△	R911	QRD141J-183	18K 1/4W Carbon	B
△	R912	QRD141J-683S	68K 1/4W Carbon	B
△	R913	QRD141J-153S	15K 1/4W Carbon	B
△	R914	QRD141J-224	220K 1/4W Carbon	B
△	R915	QRG022J-391AM	390 2W O.M. Film	B
△	R917	QRD141J-223S	22K 1/4W Carbon	B
△	R918	QRD141J-104S	100K 1/4W Carbon	B
△	R919	QRD141J-104S	100K 1/4W Carbon	B
△	R920	QRD141J-823S	82K 1/4W Carbon	B
△	R921	QRD141J-563S	56K 1/4W Carbon	B
△	R922	QRD141J-820S	82 1/4W Carbon	B
△	R931	QRD125J-221	220 1/2W UNF. Carbon	B
△	R932	QRD125J-221	220 1/2W UNF. Carbon	B
△	R950	QRD141J-472S	4.7K 1/4W Carbon	B
△	R999	QRD141J-473S	47K 1/4W Carbon	B
△	VR501	QVUB01C-E15B	Variable	B
△	VR502	QVUB01C-E15B	Variable	B

△ Safety parts

Others

Item	Part Number	Description	Area	
△	E11088-002	Circuit Board	A	
△	E11088-002	Circuit Board	B	
△	E11088-002	Circuit Board	C	
△	E11088-002	Circuit Board	D	
△	E11088-002	Circuit Board	F	
△	E11088-002	Circuit Board	G	
△	E11088-002BS	Circuit Board	EBS	
△	E303213-001	Heat Sink	A	
△	SBS3008Z	Screw	A	
△	QMC0437-002	AC Socket	A	
△	QMC0437-002	AC Socket	B	
△	QMC0440-001	AC Socket	C	
△	B45524-002	Fuse Clip	A	
△	B45524-002	Fuse Clip	B	
△	8MB50TV-501A	Speaker Terminal	A	
△	B67764-102	Terminal Ass'y	A	
△	B67764-102	Terminal Ass'y	B	
△	B67764-102	Terminal Ass'y	C	
△	B67764-202	Wrapping Terminal	A	
△	B67764-202	Wrapping Terminal	B	
△	B67764-202	Wrapping Terminal	D	
△	B67764-202	Wrapping Terminal	EBS	
△	B67764-202	Wrapping Terminal	F	
△	B67764-202	Wrapping Terminal	G	
△	B65508-002	Tab	A	
△	BM07331-001	Fuse Clip	D	
△	BM07331-001	Fuse Clip	EBS	
△	BM07331-001	Fuse Clip	F	
△	BM07331-001	Fuse Clip	G	
△	B71140-001	Spring	A	
△	SBS3008H	Screw	D	
△	B65654-001	Spacer	B	
△	B65654-001	Spacer	EBS	
△	B65654-001	Spacer	F	
△	B65654-001	Spacer	G	
△	B70225-001	Earth Plate	F	
△	B70859-001	Earth Plate	F	
△	P701	804365-003	3P Socket	A
△	P801	804365-006	6P Connector	A
△	P901	QMS6302-125	Headphone Jack(Silver only)	A
△	P901	QMS6302-128	Headphone Jack(Black only)	A
△	RY901	ESK5D24-218	Relay	A
△	SW001	QSP2206-001	Push Switch	A
△	SW901	QST8261-R02	Push Switch	A
△	L701	BQL0001-R45	Coil	A
△	L702	BQL0001-R45	Coil	A

△ Safety parts

1. Specifications

AMPLIFIER SECTION

78 IHF
RMS Power : 25 watts per channel, min. RMS, both channels driven, into 8 ohms from 40 Hz to 20 kHz, with no more than 0.5 % total harmonic distortion.

27 watts per channel, min. RMS, both channels driven into 8 ohms at 1 kHz with no more than 0.7 % total harmonic distortion.

Total Harmonic Distortion : 0.1 % at 25 watts (1 kHz, 8 ohms)
Input Sensitivity/Impedance
PHONO : 2.5 mV/47 kohms
TAPE PLAY/CD/VIDEO SOUND : 150 mV/40 kohms
Recording Output Level : 140 mV
Frequency Response : 20 Hz – 20 kHz, +1 dB, -1 dB (8 ohms)

Tone control
TREBLE : ± 8 dB (10 kHz)
BASS : ± 8 dB (100 Hz)
Signal to Noise Ratio
PHONO : 70 dB ('66 IHF) 59 dB (DIN)
78 dB ('78 IHF, Rec out)
TAPE PLAY/CD/VIDEO SOUND : 91 dB ('66 IHF) 64 dB (DIN)
74 dB ('78 IHF)

FM TUNER SECTION

	'78 IHF	DIN (for Europe)
Tuning Range	: 87.5 MHz – 108.0 MHz	87.5 MHz – 108.0 MHz
Usable Sensitivity	: Mono 10.8 dBf 0.95 μ V/75 ohms 1.9 μ V/300 ohms	1.5 μ V/75 ohms
50 dB Quieting Sensitivity	: Mono 16.3 dBf (1.8 μ V/75 ohms) (3.6 μ V/75 ohms) Stereo 38.3 dBf (22.5 μ V/75 ohms) (45 μ V/300 ohms)	—
S/N 46 dB Stereo Sensitivity	: —	Stereo 23 μ V/75 ohms
Signal to Noise Ratio (at 98 MHz, 80 dBf)	: Mono 80 dB Stereo 73 dB (A-net,)	Mono 72 dB Stereo 64 dB (weighted)
Total Harmonic Distortion	: Mono 0.15 %	Mono 0.1 %
1 kHz Frequency Response	: Stereo 0.20 % 30 Hz – 15 kHz, +0.3 dB, -5 dB	Stereo 0.3 %
Capture Ratio	: 1.5 dB	1.0 dB
Alternate Channel Selectivity	: 60 dB, ± 400 kHz	55 dB, ± 300 kHz
Image Response Ratio	: —	55 dB at 98 MHz
IF Response Ratio	: —	85 dB at 98 MHz
Stereo Separation	: —	40 dB at 1 kHz

AM TUNER SECTION

	'78 IHF	DIN (for Europe)
MW		
Tuning Range		
Channel space 9 kHz	: 522 kHz – 1611 kHz	522 kHz – 1611 kHz
Channel space 10 kHz	: 520 kHz – 1710 kHz	
Sensitivity	: 350 μ V/m at 1000 kHz 30 μ V at 1000 kHz	350 μ V/m at 999 kHz 30 μ V at 999 kHz
Signal to Noise Ratio (100mV/m)	: 50 dB at 1000 kHz	50 dB at 999 kHz
Selectivity	: 38 dB, ± 10 kHz at 1000 kHz	45 dB for R-X110L/LB at 999 kHz 35 dB, ± 9 kHz at 999 kHz

LW (R-X110L only)

Tuning Range : 153 Hz – 360 kHz
Sensitivity : 600 μ V/m at 245 kHz
100 μ V at 245 kHz
Signal to Noise Ratio (100 mV/m) : 45 dB at 245 kHz
Selectivity : 45 dB ± 9 kHz at 245 kHz

Design and specifications subject to change without notice.

Power Specifications

Areas	Line Voltage & Frequency	Power Consumption
U.S.A., Canada	AC 120 V, 60 Hz	100 W, 130 VA
Europe	AC 220 V \sim , 50 Hz	80 watts
U.K., Australia	AC 240 V \sim , 50 Hz	80 watts
Other Areas	AC 110/120/220/240 V \sim , Selectable, 50/60 Hz	80 watts

Dimensions and Weight

Height	Dimensions		Weight Net
	Width	Depth	
92 mm (3-5/8")	435 mm (17-1/8")	265 mm (10-7/16")	3.8 kg (8.4 lbs)

3. Removal Procedures

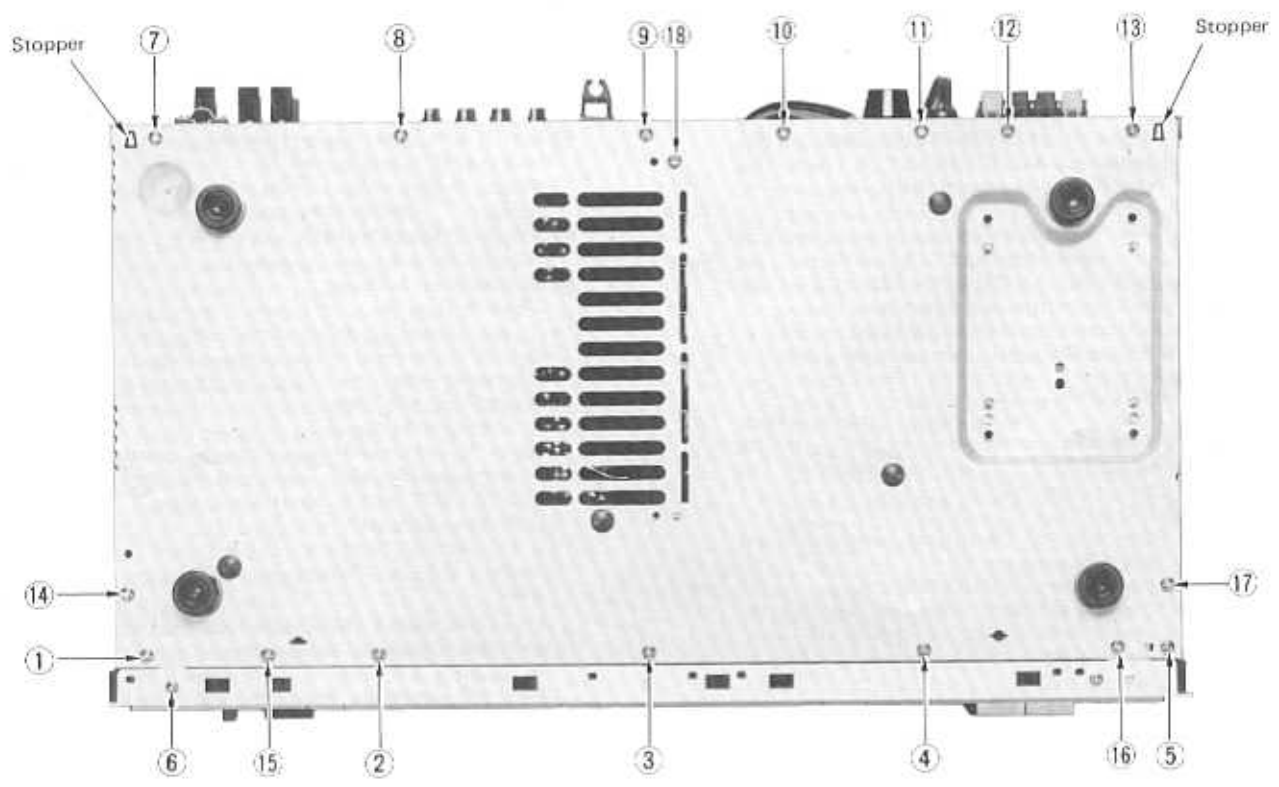
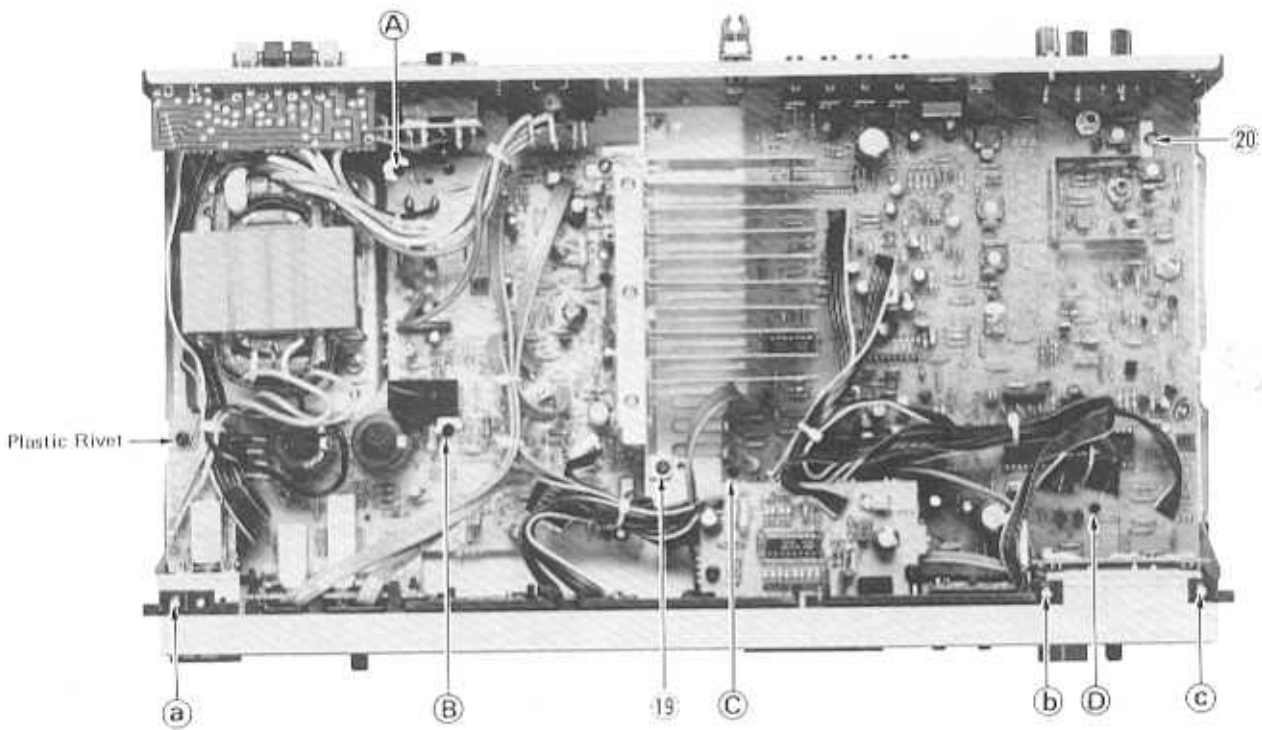

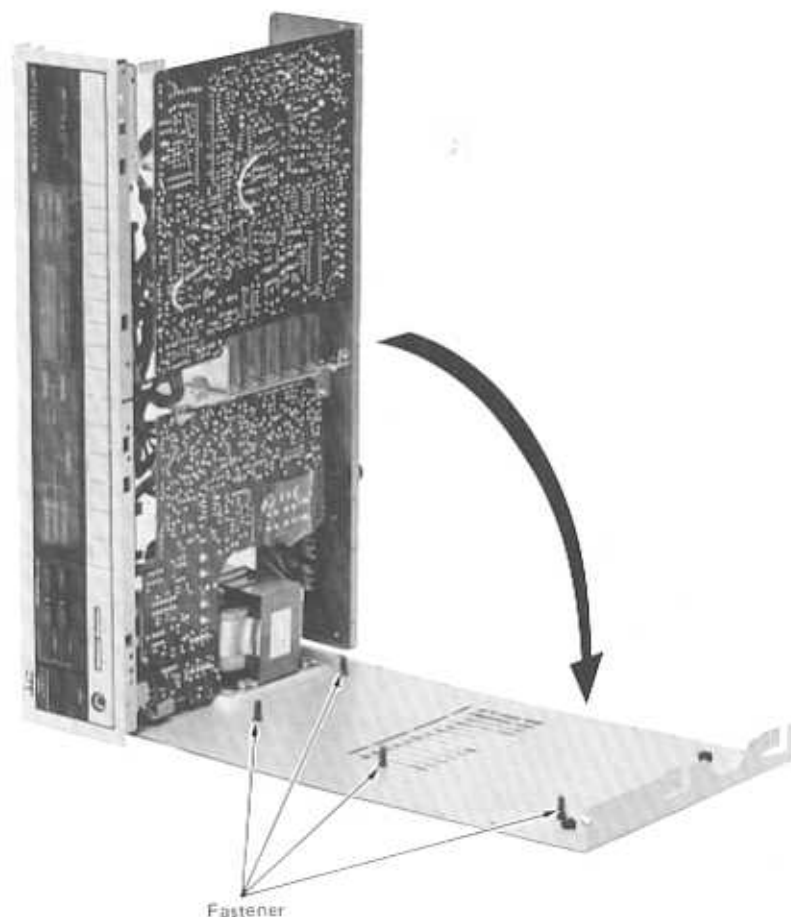

3-(1) Metal Cover Section

1. Remove the screws securing the metal cover – two screws from its two sides and three from its rear side.
2. Extract the metal cover while lifting its rear side.

3-(2) Front Panel Section

1. Demount the metal cover (refer to item 3-(1) above).
2. Remove three screws (a), (b) and (c).
3. Remove five screws (1) through (5) – namely, those screws that jointly secure the front panel and the chassis base through the panel bottom side.
4. Remove screw (6) – the one that secures the front panel through its lower side.

3-(3) Chassis Base Section

1. Demount the metal cover (refer to item 3-(1) above).
2. Remove 16 screws (1) through (5) and (7) through (17) – those screws that secure the chassis base through its bottom side.
3. Remove two screws (18) and (19) securing the heat sink.
4. Remove screw (20) securing the tuner PC board.
5. Extract the plastic rivet securing the amplifier PC board.
6. Remove four fasteners (A), (B), (C), and (D) securing the tuner PC board and the amplifier PC board. (Push in the fasteners while using radio-repair pliers or a similar tool to grip the fastener head.)
7. Open the chassis base while loosening the stopper engaged with the rear panel.

4. FM/AM (MW/LW) Tuner Alignment Procedures

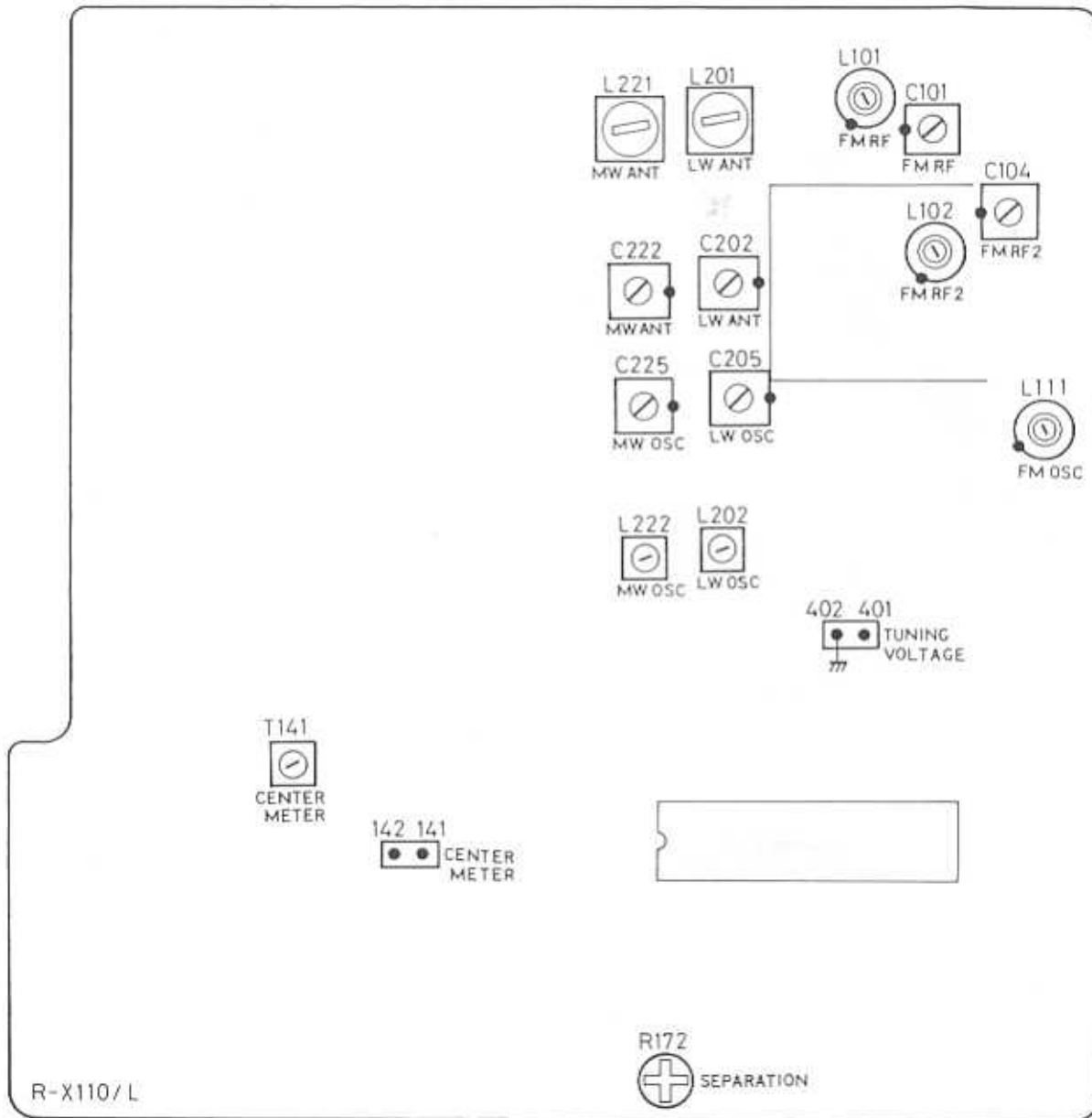

Fig. 6

FM Section

Band Cover

1. Set the frequency display to 108.0 MHz.
2. Connect a DC, VTVM, to TP401 and TP402 (GND).
3. Adjust L111 so that the VTVM. shows 9.00 V.
4. And set the frequency display to 87.5 MHz.
5. Check the VTVM. voltage reading $1.60 \text{ V} \pm 0.5 \text{ V}$.

Note: After adjustment, confirm that the band cover is as follows: (for West Germany only)

FM: Low-end 87.5 MHz -300 kHz
High-end 108.0 MHz +500 kHz

Sensitivity

Low Frequency

1. Connect an RF generator to 75 Ω antenna terminals on the rear panel through a dummy antenna, (FM 75 Ω : 75 Ω PAD)

2. Set an RF generator to 90 MHz, a modulation of 1 kHz and a deviation of 75 kHz to provide an input of $1 \mu\text{V}$.
3. Connect a VTVM and an oscilloscope to the Rec. out jacks on the rear panel.
4. Set the frequency display to 90 MHz.
5. Adjust coils L101, L102 to maximize the output.

High Frequency

6. Set the RF generator to 106 MHz, a modulation of 1 kHz and a deviation of 75 kHz to provide an input of $1 \mu\text{V}$.
7. Set the Frequency Display to 106 MHz.
8. Adjust the FM trimmers C101, C104 to maximize the output.
9. Repeat these high and low frequencies adjustment alternately until maximum sensitivity is obtained.

Discriminator, Distortion and Signal Gain

1. Press to FM position.
2. Connect an RF generator, 1 kHz modulation and a 75 kHz deviation to the antenna terminals on the rear panel through a dummy antenna.
3. Connect an oscilloscope, Distortion Meter and VTVM to the Rec. out jacks on the rear panel.
4. Set the RF generator to 98 MHz, generator output to minimize.
5. Set the Frequency Display to a 98 MHz.
6. Connect a DC VTVM between TP141 and TP142.
7. And set the RF generator output to 0.5 mV.
8. Adjust the core of T141 for DC VTVM reading of 0 (zero) mV.

Stereo Separation (for Europe, U.K. and Australia only)

1. Set the stereo signal generator as follows: 400 Hz modulation frequency, 7.5 kHz deviation pilot, 67.5 kHz main and sub carriers. Connect its output to the RF generator.
2. Connect an RF generator to the antenna terminals through a dummy antenna.
3. Switch the selector of stereo modulator to left channel modulation.
4. Adjust R172 so that the output of right channel is minimized.
5. Switch the selector of the modulator to right channel modulation.
6. Adjust R172 so that the left channel is minimized.
7. Set R172 to an average, if the separation of left and right is different.

AM(MW) Section**Band Cover**

1. Press to AM(MW) position.
2. Set the frequency display to 520 kHz (10 kHz channel step), or 522 kHz (9 kHz channel step).
3. Connect DC VTVM. TP401 and TP402 (GND).
4. Adjust L222 so that the VTVM. shows 0.95 V.
5. And set the frequency display to 1710 kHz (10 kHz channel step), or 1611 kHz (9 kHz channel step).
6. Adjust C225 so that the DC VTVM. reads 9.00 V for 1710 kHz, or 7.50 V for 1611 kHz.

Tracking and Sensitivity

Note: Be sure to perform this adjustment posterior to the LW tracking adjustment.

1. Connect the loop antenna. Also connect the RF generator to the antenna terminal on the rear panel.
2. Set the generator to 600 kHz (or 603 kHz) with 30 % modulation at 400 Hz.
3. Set the frequency display to 600 kHz, or 603 kHz.
4. Adjust the core of L221 to maximize the output.
5. Set the generator to 1400 kHz, or 1404 kHz.
6. Set the frequency display of the unit to 1400 kHz, or 1404 kHz.
7. Adjust C222 so that the output signal is maximized.
8. Repeat these adjustments (1 ~ 7) alternately until maximum sensitivity is obtained.

LW Section**Band Cover**

1. Press to LW position.
2. Set the frequency display to 153 kHz.
3. Connect a DC VTVM. to TP401 and TP402 (GND).
4. Adjust L202 so that the VTVM. shows 1.10 V.
5. Set the frequency display to 360 kHz.
6. Adjust C205 so that the VTVM. reads 8.00 V.

Tracking and Sensitivity

1. Connect the loop antenna. Also connect the RF generator to the antenna terminal on the rear panel.
2. Set the generator to 164 kHz with 30 % modulation at 400 kHz.
3. Set the frequency display to 164 kHz.
4. Adjust the core of L201 to maximize the output.
5. Set the frequency generator to 353 kHz.
6. Set the frequency display of the unit to 353 kHz.
7. Adjust C202 so that the output signal is maximized.
8. Repeat these adjustments (1 ~ 7) alternately until maximum sensitivity is obtained.

5. Block Diagram

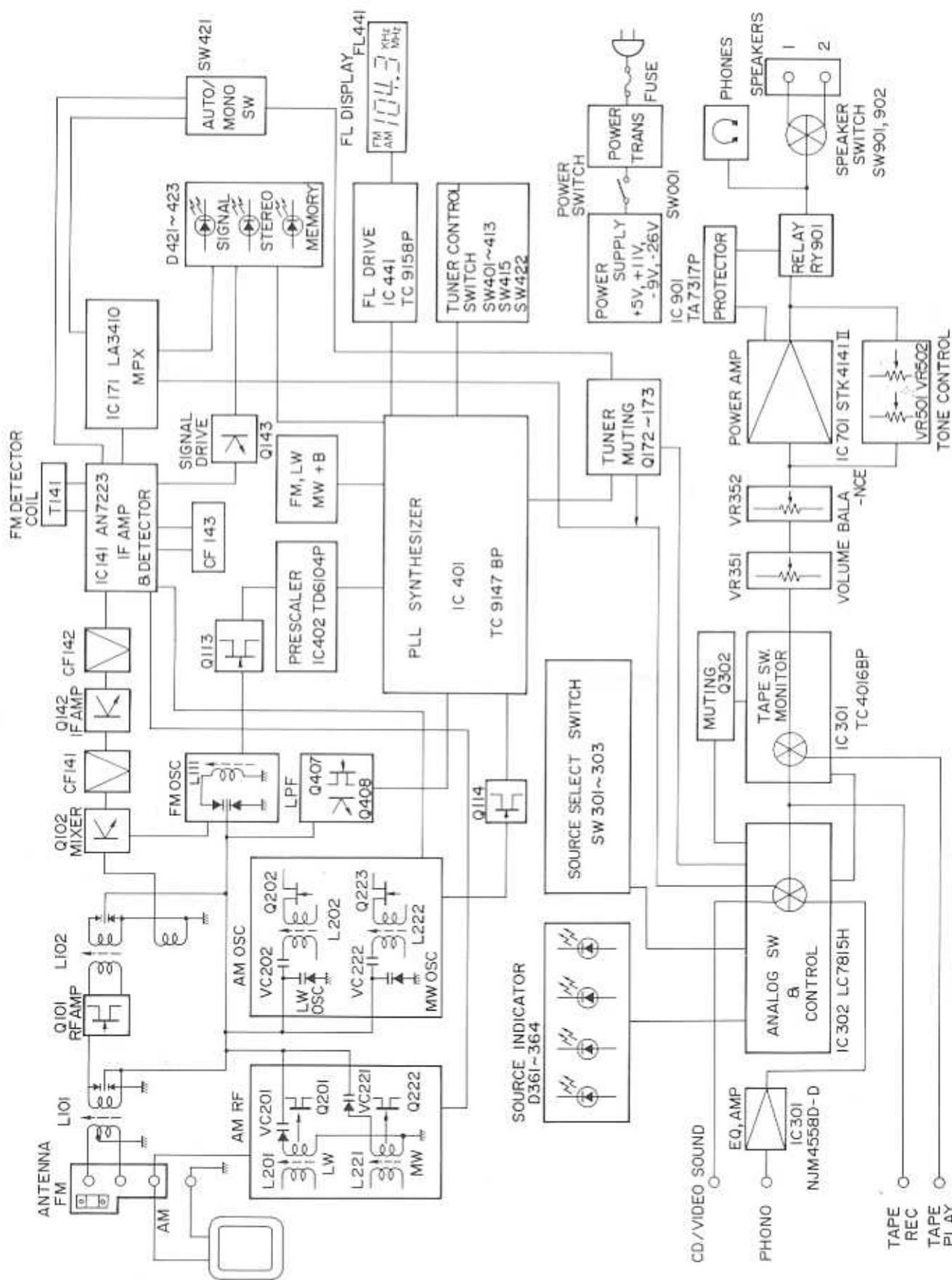

6-(2) R-X110L Tunner Section

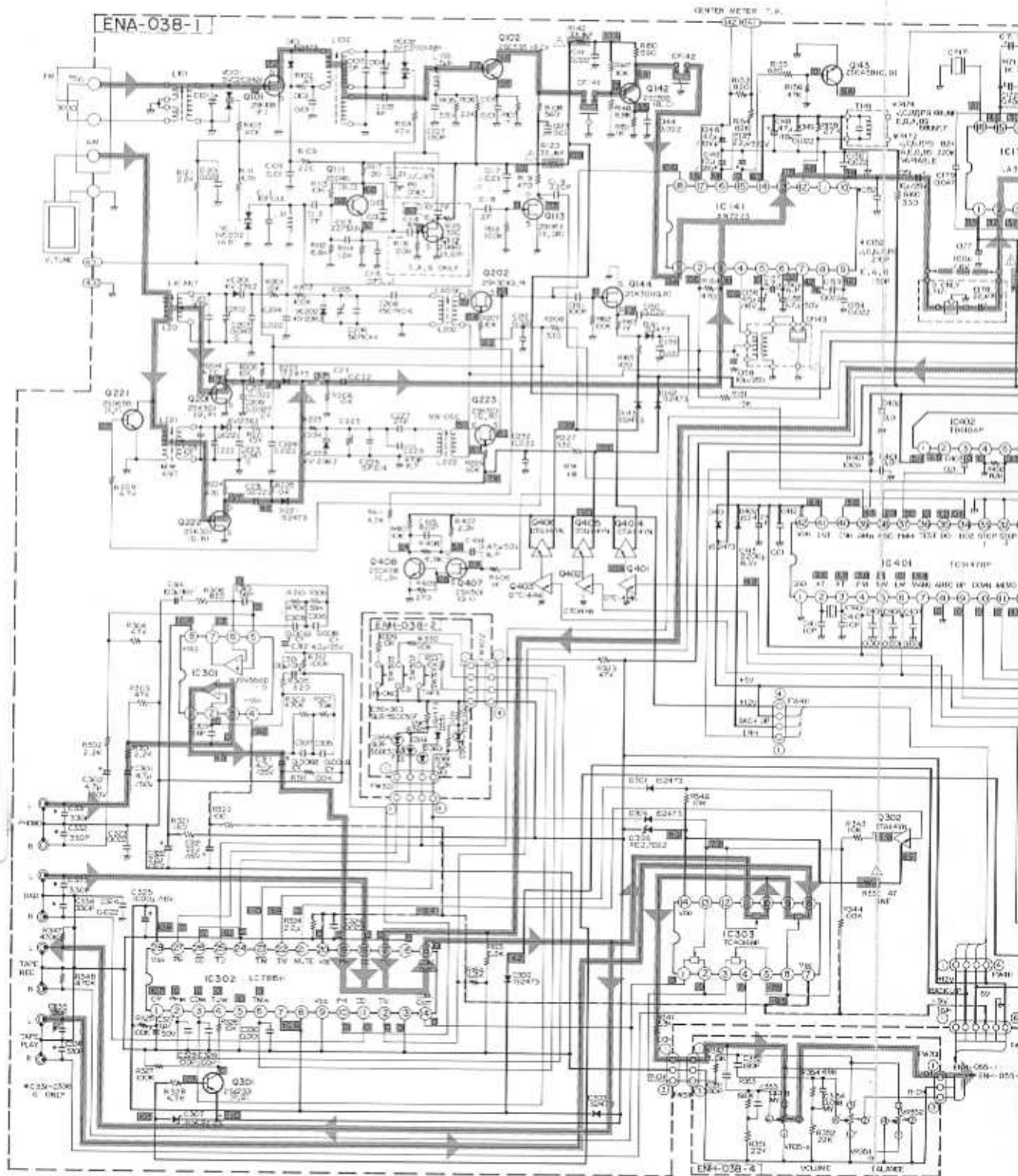

Notes:

1. shows DC voltage to the chassis with no signal input.
2. indicates positive B power supply.
3. indicates negative B power supply.
4. indicates signal path.
5. When replacing the parts in the darkened area () and those marked with , be sure to use the designated parts to ensure safety.
6. This is the standard circuit diagram. The design and contents are subject to change without notice.

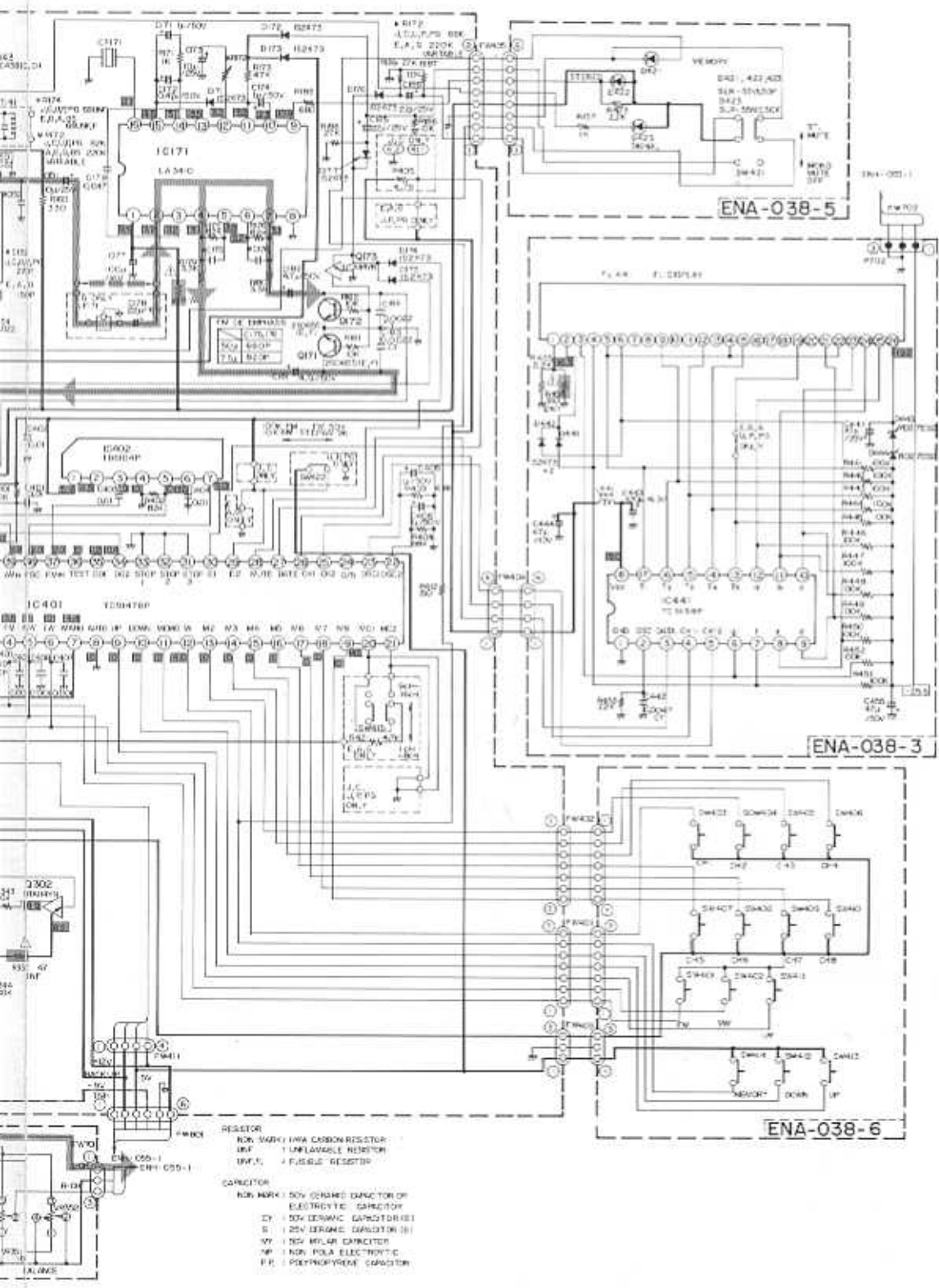

and
ated
out

6-(3) R-X110/R-X110L Amplifier Section

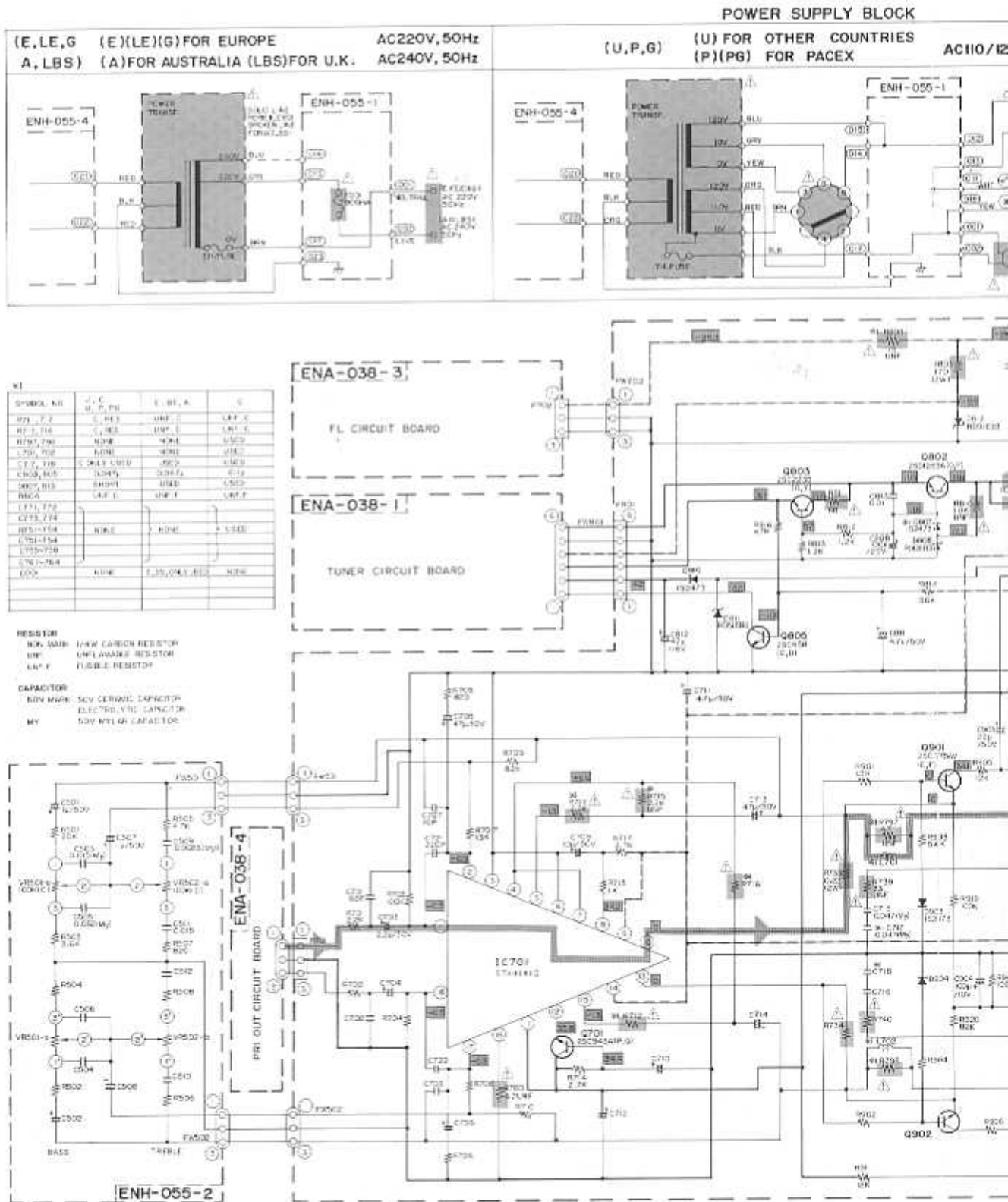

Notes:

1. shows DC voltage to the chassis with no signal input.
2. indicates positive B power supply.
3. indicates negative B power supply.
4. indicates signal path.

5. When replacing the parts in the darkened area () and those marked with , be sure to use the designated parts to ensure safety.
6. This is the standard circuit diagram. The design and contents are subject to change without notice.

POWER SUPPLY BLOCK

OTHER COUNTRIES
FOR PACEX

AC110/120/220/240V, 50/60Hz

(J,C) (J) FOR U.S.A
(C) FOR CANADA

AC120V, 60Hz

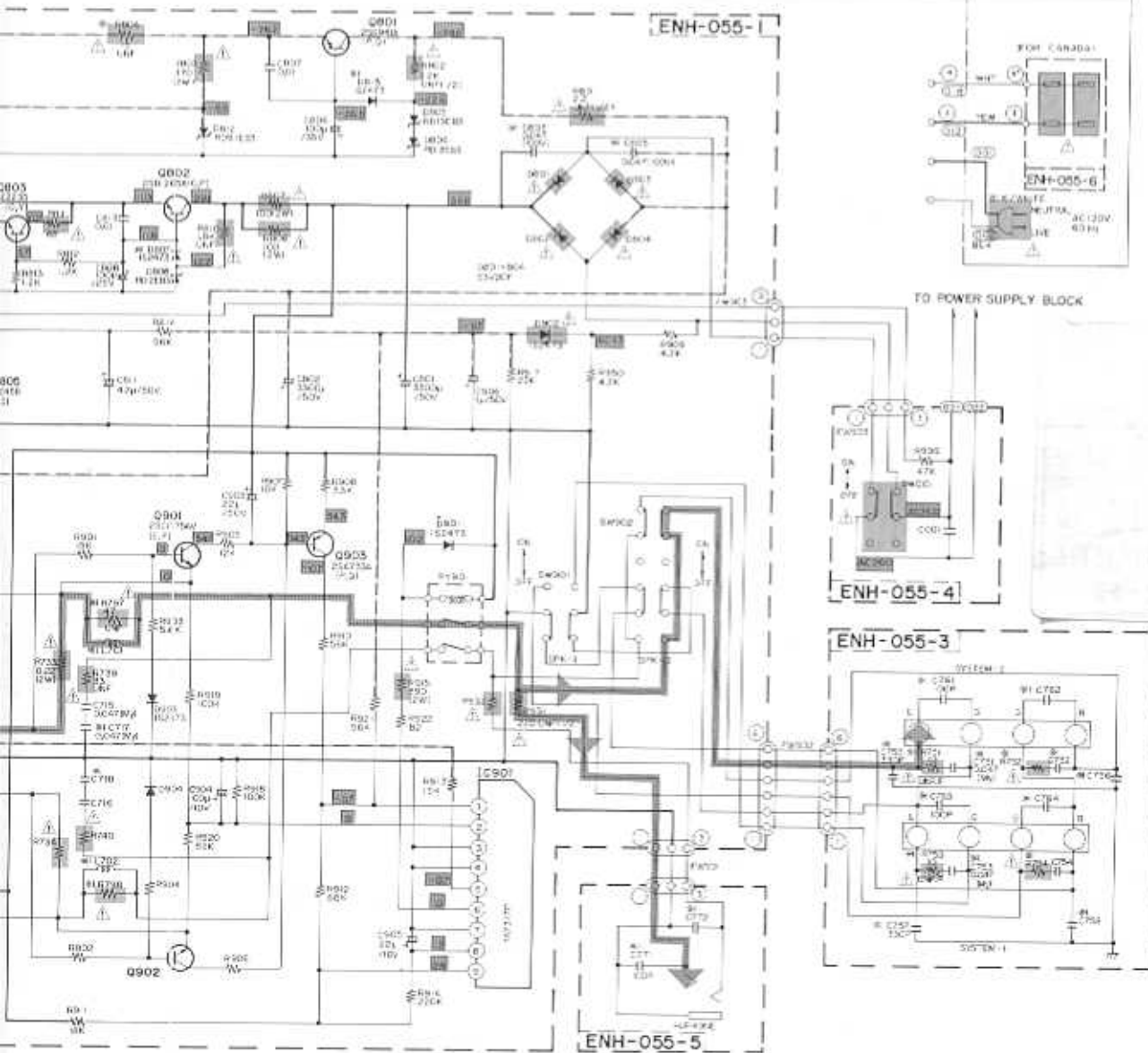
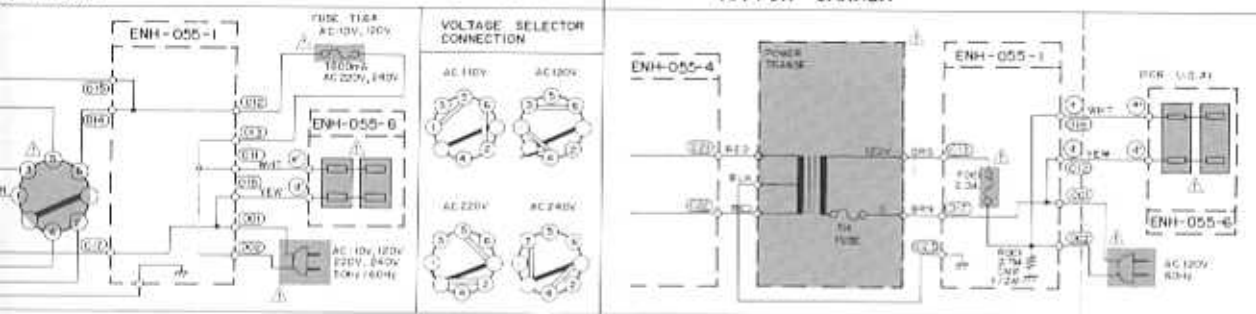

and
designated

without